

Order example

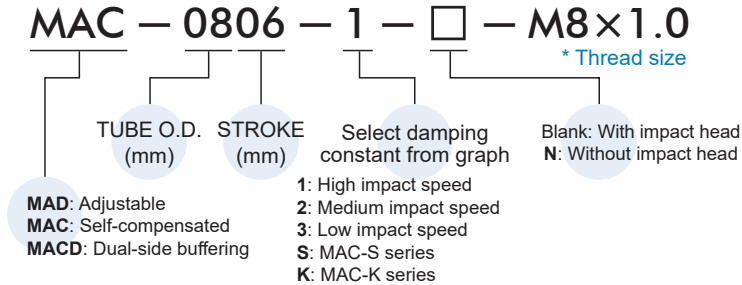

Why do we need shock absorbers?

The simplest method to increase productivity is to raise machine operation speed. It often accompanies with excessive vibration and noise, damage to machines and products and decreasing in machine life. Most important of all, safety has to be sacrificed to a certain degree because of large shock forces generated.

MINDMAN shock absorbers are developed to provide linear deceleration and therefore solve these problems. They can stop or change direction of moving objects smoothly and quietly without any compromising in safety. MINDMAN shock absorbers are ideal for energy absorption and are being used whenever shock forces occur.

The advantages of using shock absorbers include

1. To increase production rate.
2. To extend machine life.
3. To simplify equipment design.
4. To reduce maintenance cost.
5. To reduce vibration and noise levels.

Comparison of shock absorbing of dash pots, rubber materials springs, cylinder cushion and shock absorbers

In case of MINDMAN shock absorbers compared with other buffering devices, such as spring, dash pots, air buffers, or rubber materials, resistant forces are different from one another. Only MINDMAN shock absorbers can stop a moving object smoothly and quietly from the beginning to the end of impact stroke. Figure 1 shows a scheme of comparing shock forces generated by different cushioning materials. Through special design of fluid metering system, MINDMAN shock absorbers can provide a constant resistant force or linear deceleration throughout the entire impact stroke, all the kinetic energy of the moving object is converted into heat and dissipated into the air.

Springs, air buffers and rubber materials only dissipate a small portion of the kinetic energy and store the remaining in elastic energy form. Therefore, large resistant forces and rebounding forces are inevitable near the end of the impact stroke. Without a delicate metering system, a dash pot will produce a large peak force at the beginning of the impact stroke.

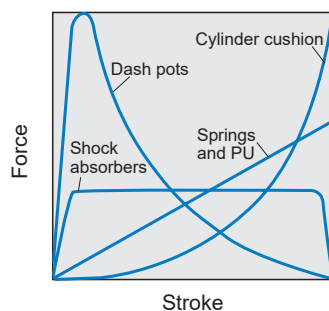

Operating principles of shock absorbers

All series of MINDMAN shock absorbers are of such construction as shown in the following drawing. On impact the piston rod moves into the shock absorber and the hydraulic fluid is pushed into accumulator to produce resistant force. Owing to special spacing and sizing of orifices, the pressure in the inner tube remains constant throughout the entire impact stroke. By providing a linear deceleration, a MINDMAN shock absorber brings the impacting object to stop smoothly and quiet. At the end of the impact stroke, the return spring pushes the piston to its original piston for next cycle.

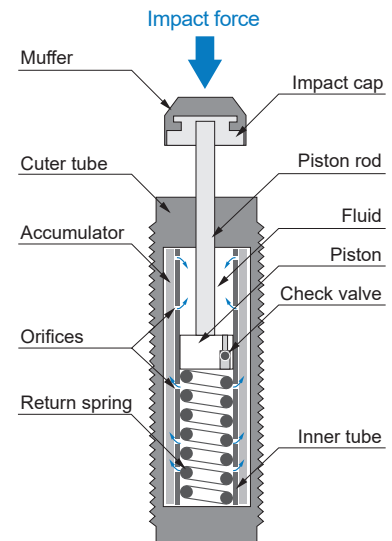

Construction of a shock absorber

Considerations for selecting shock absorbers

1. Moving direction. (in horizontal, free fall or rotary motion)
2. Total weight of impacting object.
3. Propelling force. (pneumatic / hydraulic cylinder, motor etc.)
4. Impact Velocity.
5. Number of impact per hour.
6. Applicable quantity of shock absorbers in impacting direction.

Functions of hydraulic shock absorbers

1. Eliminating vibration and absorbing striking energy in a short time.
2. Reducing operating noise and offering a quiet working environment.
3. Accelerating machine operation and elevating production capacity.
4. Extending machine life time and reducing after sale service.
5. Improving quality of products.

Applications

Robots for plastic injection moulding machine, pick and place robots, feeding equipment, screen print machines, conveyors, air cylinders, vibration conveyor systems, rolling doors, medical equipment, foundry industries, rodless cylinders, package machines, machine tools, rubber/plastic machines, woodworking machines, aircraft industries, military equipment, education researches and automotive transfer lines.

* Customer's own specification is welcome.

* The specifications are subject to change without advance notice.



MAC series

Mini type - M8, M10, M12

Our miniature shock absorbers MAC Series- M8, M10, M12 provide great effect for shock impact and come to stop smoothly and are ideal for light loads.

Specification

Model	Stroke (mm)	Max. Nm per cycle (Nm)	Max. Nm per hour (Nm)	Max. effective mass (kg)	Max. impact speed (m/s)	Without impact head	With impact head	Operating temp. (°C) (No freezing)	Stop collar (SC)
MAC-0806-1	6	2	8800	0.5	2.0	○	○	-10~+80	SC-08
MAC-0806-2	6	2	8800	2	1.0	○	○	-10~+80	SC-08
MAC-0806-3	6	2	8800	6	0.5	○	○	-10~+80	SC-08
MAC-1005-1	5	3	10800	1	3.0	○	○	-10~+80	SC-10
MAC-1005-2	5	3	10800	3	1.5	○	○	-10~+80	SC-10
MAC-1005-3	5	3	10800	7	0.8	○	○	-10~+80	SC-10
MAC-1008-1	8	4	15200	2	3.0	○	○	-10~+80	SC-10
MAC-1008-2	8	4	15200	4	1.5	○	○	-10~+80	SC-10
MAC-1008-3	8	4	15200	9	0.8	○	○	-10~+80	SC-10
MAC-1210-1	10	5	17640	5	3.0	○	○	-10~+80	SC-12
MAC-1210-2	10	5	17640	10	1.5	○	○	-10~+80	SC-12
MAC-1210-3	10	5	17640	30	0.8	○	○	-10~+80	SC-12

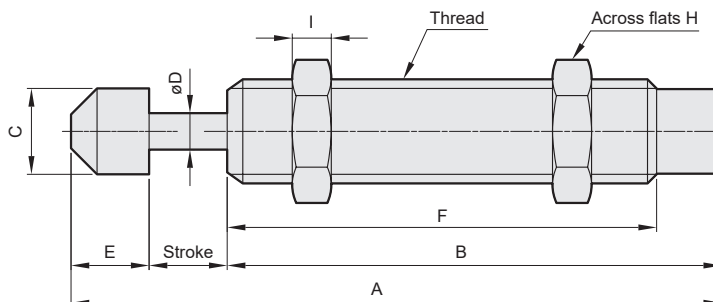

Dimensions

Model	Thread	Stroke (mm)	A	B	C	D	E	F	H	I	Weight (g)
MAC-0806-1	M8×1.0/0.75	6	50	38	6.6	3	6	33	11	3	11
MAC-0806-2	M8×1.0/0.75	6	50	38	6.6	3	6	33	11	3	11
MAC-0806-3	M8×1.0	6	50	38	6.6	3	6	33	11	3	11
MAC-1005-1	M10×1.0	5	38.7	27.7	8.6	2.8	6	22.9	12.7	3	14
MAC-1005-2	M10×1.0	5	38.7	27.7	8.6	2.8	6	22.9	12.7	3	14
MAC-1005-3	M10×1.0	5	38.7	27.7	8.6	2.8	6	22.9	12.7	3	14
MAC-1008-1	M10×1.0	8	57	43	8.6	3	6	38	12.7	3	20
MAC-1008-2	M10×1.0	8	57	43	8.6	3	6	38	12.7	3	20
MAC-1008-3	M10×1.0	8	57	43	8.6	3	6	38	12.7	3	20
MAC-1210-1	M12×1.0	10	69.5	50	10.3	3	9.5	45.5	14	4	31.5
MAC-1210-2	M12×1.0	10	69.5	50	10.3	3	9.5	45.5	14	4	31.5
MAC-1210-3	M12×1.0	10	69.5	50	10.3	3	9.5	45.5	14	4	31.5

Specification



MAC series Porous fixed type - M14, M20

MAC series is of fixed structure. Through special design and experimented oil hole and arrange method, linear deceleration on the object in motion is achieved. From high speed light load to low speed heavy load, appropriate energy can be absorbed without any adjustment. After the load is removed, reset spring will push the axle center to its original location. For MAC series, it has three models of high speed, medium speed and low speed to satisfy your different needs.

Model	Stroke (mm)	Max. Nm per cycle (Nm)	Max. Nm per hour (Nm)	Max. effective mass (kg)	Max. impact speed (m/s)	Without impact head	With impact head	Operating temp. (°C) (No freezing)	Stop collar (SC)
MAC-1412-1	12	15	30000	8	3.0	○	○	-10~+80	SC-14
MAC-1412-2	12	15	30000	50	1.5	○	○	-10~+80	SC-14
MAC-1412-3	12	15	30000	100	0.8	○	○	-10~+80	SC-14
MAC-1416-1	16	20	35000	10	3.0	○	○	-10~+80	SC-14
MAC-1416-2	16	20	35000	70	1.5	○	○	-10~+80	SC-14
MAC-1416-3	16	20	35000	150	0.8	○	○	-10~+80	SC-14
MAC-1420-1	20	20	35000	10	3.0	○	○	-10~+80	SC-14
MAC-1420-2	20	20	35000	70	1.5	○	○	-10~+80	SC-14
MAC-1420-3	20	20	35000	150	0.8	○	○	-10~+80	SC-14
MAC-1425-1	25	28	37000	20	3.0	○	○	-10~+80	SC-14
MAC-1425-2	25	28	37000	150	1.5	○	○	-10~+80	SC-14
MAC-1425-3	25	28	37000	250	0.8	○	○	-10~+80	SC-14
MAC-2020-1	20	40	40000	30	3.5	○	○	-10~+80	SC-20
MAC-2020-2	20	40	40000	200	2.0	○	○	-10~+80	SC-20
MAC-2020-3	20	40	40000	700	1.0	○	○	-10~+80	SC-20
MAC-2030-1	30	50	48000	30	3.5	○	○	-10~+80	SC-20
MAC-2030-2	30	50	48000	200	2.0	○	○	-10~+80	SC-20
MAC-2030-3	30	50	48000	700	1.0	○	○	-10~+80	SC-20

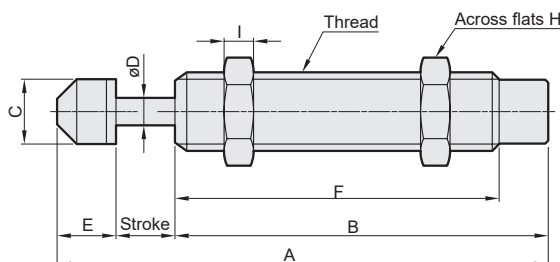

Dimensions

Model	Thread	Stroke (mm)	A	B	C	D	E	F	H	I	Weight (g)
MAC-1412-1	M14×1.0/1.5	12	99.2	76	12	4	11.2	67	19	5	80
MAC-1412-2	M14×1.0/1.5	12	99.2	76	12	4	11.2	67	19	5	80
MAC-1412-3	M14×1.0/1.5	12	99.2	76	12	4	11.2	67	19	5	80
MAC-1416-1	M14×1.0/1.5	16	122.2	95	12	4	11.2	86	19	5	85
MAC-1416-2	M14×1.0/1.5	16	122.2	95	12	4	11.2	86	19	5	85
MAC-1416-3	M14×1.0/1.5	16	122.2	95	12	4	11.2	86	19	5	85
MAC-1420-1	M14×1.5	20	126.2	95	12	4	11.2	86	19	5	95
MAC-1420-2	M14×1.5	20	126.2	95	12	4	11.2	86	19	5	95
MAC-1420-3	M14×1.5	20	126.2	95	12	4	11.2	86	19	5	95
MAC-1425-1	M14×1.0/1.5	25	146.2	110	12	4	11.2	101	19	5	105
MAC-1425-2	M14×1.0/1.5	25	146.2	110	12	4	11.2	101	19	5	105
MAC-1425-3	M14×1.0/1.5	25	146.2	110	12	4	11.2	101	19	5	105
MAC-2020-1	M20×1.5/2.0	20	145.3	110	17.8	6	15.3	101	26	7	215
MAC-2020-2	M20×1.5	20	145.3	110	17.8	6	15.3	101	26	7	215
MAC-2020-3	M20×1.5	20	145.3	110	17.8	6	15.3	101	26	7	215
MAC-2030-1	M20×1.5/2.0	30	158.3	113	17.8	6	15.3	104	26	7	220
MAC-2030-2	M20×1.5/2.0	30	158.3	113	17.8	6	15.3	104	26	7	220
MAC-2030-3	M20×1.5	30	158.3	113	17.8	6	15.3	104	26	7	220

Specification



Model	Stroke (mm)	Max. Nm per cycle (Nm)	Max. Nm per hour (Nm)	Max. effective mass (kg)	Max. impact speed (m/s)	Without impact head	With impact head	Operating temp. (°C) (No freezing)	Stop collar (SC)
MAC-2050-1	50	60	60000	60	3.5	○	○	-10~+80	SC-20
MAC-2050-2	50	60	60000	400	2.0	○	○	-10~+80	SC-20
MAC-2050-3	50	60	60000	1200	1.0	○	○	-10~+80	SC-20
MAC-2525-1	25	80	54000	200	4.0	○	○	-10~+80	SC-25
MAC-2525-2	25	80	54000	800	2.5	○	○	-10~+80	SC-25
MAC-2525-3	25	80	54000	1500	1.0	○	○	-10~+80	SC-25
MAC-2540-1	40	120	75000	300	4.0	—	○	-10~+80	SC-25
MAC-2540-2	40	120	75000	1200	2.5	—	○	-10~+80	SC-25
MAC-2540-3	40	120	75000	2000	1.0	—	○	-10~+80	SC-25
MAC-2550-1	50	135	90000	200	4.0	○	○	-10~+80	SC-25
MAC-2550-2	50	135	90000	900	2.5	○	○	-10~+80	SC-25
MAC-2550-3	50	135	90000	1680	1.0	○	○	-10~+80	SC-25
MAC-2580-1	80	150	120000	150	4.0	○	○	-10~+80	SC-25
MAC-2580-2	80	150	120000	600	2.5	○	○	-10~+80	SC-25
MAC-2580-3	80	150	120000	1200	1.0	○	○	-10~+80	SC-25

MAC series

Porous fixed type - M20, M25

Model M20, M25 are applicable for high impact and high effectiveness.

MAC-2050 MAC-2525

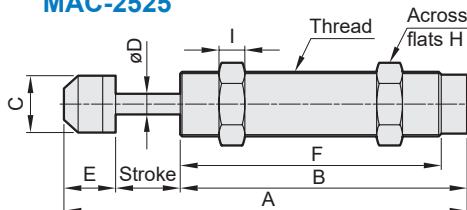

MAC-2540

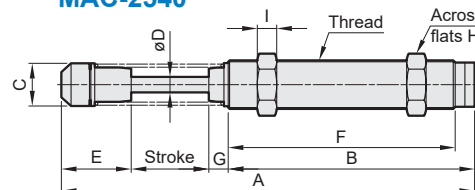

MAC-2550 MAC-2580

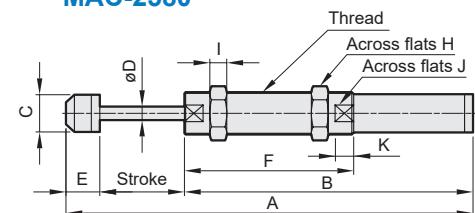

Dimensions

Model	Thread	Stroke (mm)	A	B	C	D	E	F	G	H	I	J	K	Weight (g)
MAC-2050-1	M20×1.5/2.0	50	232.8	167	17.8	6	15.8	158	—	26	7	—	—	300
MAC-2050-2	M20×1.5	50	232.8	167	17.8	6	15.8	158	—	26	7	—	—	300
MAC-2050-3	M20×1.5	50	232.8	167	17.8	6	15.8	158	—	26	7	—	—	300
MAC-2525-1	M25×1.5/2.0	25	155	111	22	8	19	101	—	32	9	—	—	330
MAC-2525-2	M25×1.5/2.0	25	155	111	22	8	19	101	—	32	9	—	—	330
MAC-2525-3	M25×1.5/2.0	25	155	111	22	8	19	101	—	32	9	—	—	330
MAC-2540-1	M25×1.5/2.0	40	214	127	22	8	37	117	10	32	9	—	—	430
MAC-2540-2	M25×1.5/2.0	40	214	127	22	8	37	117	10	32	9	—	—	430
MAC-2540-3	M25×1.5/2.0	40	214	127	22	8	37	117	10	32	9	—	—	430
MAC-2550-1	M25×1.5/2.0	50	239.5	170.5	22	8	19	100	—	32	9	22.8	11	435
MAC-2550-2	M25×1.5/2.0	50	239.5	170.5	22	8	19	100	—	32	9	22.8	11	435
MAC-2550-3	M25×1.5/2.0	50	239.5	170.5	22	8	19	100	—	32	9	22.8	11	435
MAC-2580-1	M25×1.5/2.0	80	336	237	22	8	19	100	—	32	9	22.8	11	535
MAC-2580-2	M25×1.5/2.0	80	336	237	22	8	19	100	—	32	9	22.8	11	535
MAC-2580-3	M25×1.5/2.0	80	336	237	22	8	19	100	—	32	9	22.8	11	535



MAC series

Porous fixed type - M36

MAC series is self-compensating, and ideal for energy absorption in high speed, medium speed and low speed impact. MAC series can stop moving objects smoothly and quietly.

Specification

Model	Stroke (mm)	Max. Nm per cycle (Nm)	Max. Nm per hour (Nm)	Max. effective mass (kg)	Max. impact speed (m/s)	Without impact head	With impact head	Operating temp. (°C) (No freezing)	Stop collar (SC)	Flange (F)
MAC-3660-1	60	250	120000	400	4.0	—	○	-10~+80	SC-36	F36
MAC-3660-2	60	250	120000	1500	2.5	—	○	-10~+80	SC-36	F36
MAC-3660-3	60	250	120000	2400	1.0	—	○	-10~+80	SC-36	F36

MAC-3660

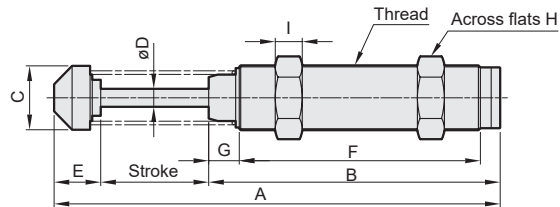

Dimensions

Model	Thread	Stroke (mm)	A	B	C	D	E	F	G	H	I	Weight (g)
MAC-3660-1	M36×1.5	60	248	162	35.5	10	26	134	17	46	15	1030
MAC-3660-2	M36×1.5	60	248	162	35.5	10	26	134	17	46	15	1030
MAC-3660-3	M36×1.5	60	248	162	35.5	10	26	134	17	46	15	1030



Specification

Model	Stroke (mm)	Max. Nm per cycle (Nm)	Max. Nm per hour (Nm)	Max. effective mass (kg)	Max. impact speed (m/s)	Without impact head	With impact head	Operating temp. (°C) (No freezing)	Stop collar (SC)
MAC-1415-6K	15	9.8	35280	30	1.0	—	○	-10~+80	SC-14
MAC-1415-7K	15	9.8	35280	15	1.5	—	○	-10~+80	SC-14
MAC-2020-2K	20	36	22000	27	2.0	—	○	-10~+80	SC-20
MAC-2030-5K	30	44	26460	60	1.2	—	○	-10~+80	SC-20
MAC-2030-6K	30	44	26460	30	1.7	—	○	-10~+80	SC-20
MAC-2030-7K	30	44	26460	15	2.4	—	○	-10~+80	SC-20
MAC-2030-8K	30	44	26460	8	2.8	—	○	-10~+80	SC-20
MAC-2030-16K	30	44	26460	5	4.2	—	○	-10~+80	SC-20
MAC-2030-18K	30	44	26460	3	6.0	—	○	-10~+80	SC-20
MAC-2050-10K	50	59	35280	30	2.0	—	○	-10~+80	SC-20
MAC-2050-11K	50	59	35280	30	2.0	—	○	-10~+80	SC-20
MAC-2050-12K	50	59	35280	15	2.8	—	○	-10~+80	SC-20
MAC-2050-13K	50	59	35280	8	3.8	—	○	-10~+80	SC-20
MAC-2050-16K	50	59	35280	5	5.0	—	○	-10~+80	SC-20
MAC-2050-17K	50	59	35280	3	6.8	—	○	-10~+80	SC-20

MAC-1415 MAC-2020

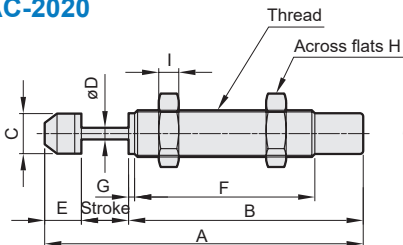

MAC-2030

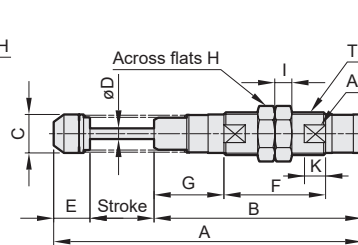

MAC-2050

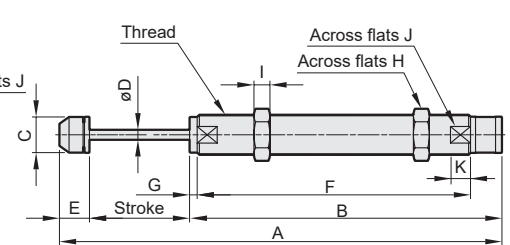

MAC-K series Porous fixed type

MAC-K series can effectively absorb the vibration and noise generated from high motion and can turn the kinetic energy into thermal energy and release it into the air. Therefore, in each action, it can stop the object stably can effectively. When our shock absorber is selected, disadvantage caused by bad shock absorber can be effectively solved, consequently, the machine efficiency can be enhanced, the production capacity can be increased, and the usage lifetime of the machine can be lengthened. MAC-K and MACD are all appropriate for high speed impact sites, the ends of long stroke moving device, and most of them are used for robot arms.

Dimensions

Model	Thread	Stroke (mm)	A	B	C	D	E	F	G	H	I	J	K	Weight (g)
MAC-1415-6K	M14×1.5	15	95.6	69.4	12	4	11.2	52.7	2	19	5	—	—	80
MAC-1415-7K	M14×1.0/1.5	15	95.6	69.4	12	4	11.2	52.7	2	19	5	—	—	80
MAC-2020-2K	M20×1.5	20	128.8	93	17.8	5	15.8	74.5	3.8	26	7	—	—	170
MAC-2030-5K	M20×1.5	30	133.7	86	17.8	5	17.7	48	21	26	7	18.2	10	185
MAC-2030-6K	M20×1.5	30	133.7	86	17.8	5	17.7	48	21	26	7	18.2	10	185
MAC-2030-7K	M20×1.5	30	133.7	86	17.8	5	17.7	48	21	26	7	18.2	10	185
MAC-2030-8K	M20×1.5	30	133.7	86	17.8	5	17.7	48	21	26	7	18.2	10	185
MAC-2030-16K	M20×1.5	30	146.5	97.8	17.8	5	18	48	32.8	26	7	18.2	10	205
MAC-2030-18K	M20×1.5	30	146.5	97.8	17.8	5	18	48	32.8	26	7	18.2	10	205
MAC-2050-10K	M20×1.5	50	221.8	156	17.8	5	15.8	136.5	4	26	7	18.2	10	250
MAC-2050-11K	M20×1.5	50	221.8	156	17.8	5	15.8	136.5	4	26	7	18.2	10	250
MAC-2050-12K	M20×1.5	50	221.8	156	17.8	5	15.8	136.5	4	26	7	18.2	10	250
MAC-2050-13K	M20×1.5	50	221.8	156	17.8	5	15.8	136.5	4	26	7	18.2	10	250
MAC-2050-16K	M20×1.5	50	221.8	156	17.8	5	15.8	136.5	4	26	7	18.2	10	250
MAC-2050-17K	M20×1.5	50	221.8	156	17.8	5	15.8	136.5	4	26	7	18.2	10	250

Specification

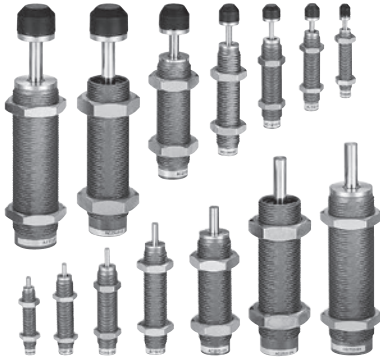

Model	Stroke (mm)	Max. Nm per cycle (Nm)	Max. Nm per hour (Nm)	Max. effective mass (kg)	Max. impact speed (m/s)	Without impact head	With impact head	Operating temp. (°C) (No freezing)	Stop collar (SC)
MAC-0806-S	6	3	7000	6	0.3~2.5	○	○	-10~+80	SC-08
MAC-1007-S	7	6	12400	12	0.3~3.5	○	○	-10~+80	SC-10
MAC-1210-S	10	12	22500	22	0.3~4.0	○	○	-10~+80	SC-12
MAC-1412-S	12	20	33000	40	0.3~5.0	○	○	-10~+80	SC-14
MAC-2015-S	15	59	38000	120	0.3~5.0	○	○	-10~+80	SC-20
MAC-2525-S	25	80	60000	180	0.3~5.0	○	○	-10~+80	SC-25
MAC-2725-S	25	147	72000	270	0.3~5.0	○	○	-10~+80	SC-27

MAC-S series

MAC-S series, as compared to MAC series, has smaller installation length, higher usage frequency, larger energy absorption, more secure product structure, and higher safety. It is applicable to equipment of compact size or of small space, and there is straight slot or milled edge to facilitate the installation.

MAC-0806-S
MAC-1007-S
MAC-1210-S

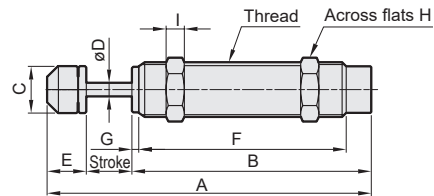

Application example

Slide unit cylinder

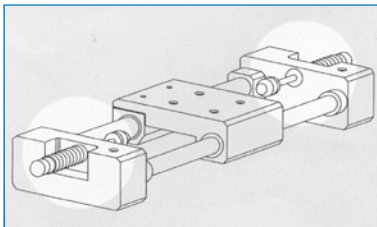

MAC-1412-S
MAC-2015-S
MAC-2525-S
MAC-2725-S

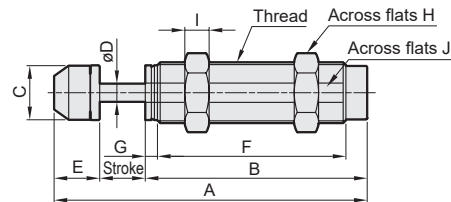

Slide unit

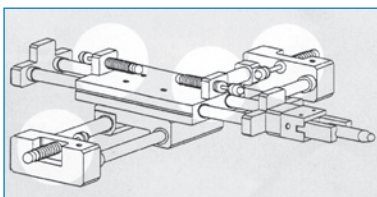

Dimensions

Model	Thread	Stroke (mm)	A	B	C	D	E	F	G	H	I	J	Weight (g)
MAC-0806-S	M8×1.0	6	55.2	40.6	6.6	2.9	8.6	33.6	2	11	3	—	17
MAC-1007-S	M10×1.0	7	62.6	47	8.6	3	8.6	39	3	12.7	3	—	28
MAC-1210-S	M12×1.0	10	71.3	52.5	10.3	3	8.8	44	3	14	4	—	32
MAC-1412-S	M14×1.5	12	90.2	67	12	4	11.2	58	4	19	5	12.1	70
MAC-2015-S	M20×1.5	15	103.3	73	17.8	6	15.3	62	4	26	7	18	160
MAC-2525-S	M25×1.5	25	136	92	22	8	19	82	—	32	9	23	295
MAC-2725-S	M27×1.5	25	143	99	22	8	19	86	5	32	6	25	375

Specification



Model	Stroke (mm)	Max. Nm per cycle (Nm)	Max. Nm per hour (Nm)	Max. effective mass (kg)	Max. impact speed (m/s)	Without impact head	With impact head	Operating temp. (°C) (No freezing)	Stop collar (SC)
MACD-2030-1	30	45	55000	40	3.5	—	○	-10~+80	SC-20
MACD-2030-2	30	45	55000	80	2.0	—	○	-10~+80	SC-20
MACD-2030-3	30	45	55000	450	1.0	—	○	-10~+80	SC-20
MACD-2035-1	35	52	63000	40	3.5	—	○	-10~+80	SC-20
MACD-2035-2	35	52	63000	200	2.0	—	○	-10~+80	SC-20
MACD-2035-3	35	52	63000	450	1.0	—	○	-10~+80	SC-20
MACD-2050-1	50	60	68000	60	3.5	—	○	-10~+80	SC-20
MACD-2050-2	50	60	68000	210	2.0	—	○	-10~+80	SC-20
MACD-2050-3	50	60	68000	480	1.0	—	○	-10~+80	SC-20

MACD series

Double cushion

MACD series has adopted dual-buffering structure, and different buffering effects are installed at both ends. It is applicable to high speed site and commonly used for robot arm. It can reduce the noise and vibration of the equipment to increase greatly the operation speed of the robot arm.

MACD-2035 MACD-2030

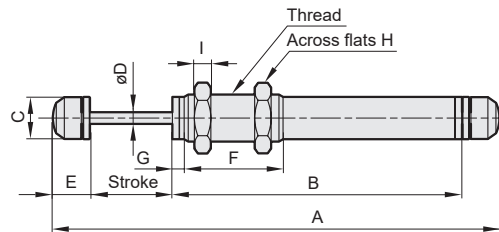

MACD-2050

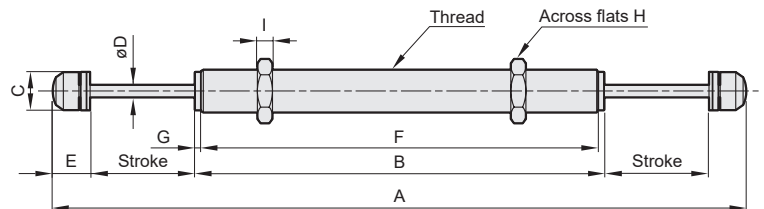

Dimensions

Model	Thread	Stroke (mm)	A	B	C	D	E	F	G	H	I	Weight (g)
MACD-2030-1	M20×1.5	30	184.6	123	17.8	6	15.8	44	3	26	7	320
MACD-2030-2	M20×1.5	30	184.6	123	17.8	6	15.8	44	3	26	7	320
MACD-2030-3	M20×1.5	30	184.6	123	17.8	6	15.8	44	3	26	7	320
MACD-2035-1	M20×1.5	35	224.6	123	17.8	5	15.8	42	5	26	7	350
MACD-2035-2	M20×1.5	35	224.6	123	17.8	5	15.8	42	5	26	7	350
MACD-2035-3	M20×1.5	35	224.6	123	17.8	5	15.8	42	5	26	7	350
MACD-2050-1	M20×1.5	50	276.6	145	17.8	6	15.8	134	3	26	7	470
MACD-2050-2	M20×1.5	50	276.6	145	17.8	6	15.8	134	3	26	7	470
MACD-2050-3	M20×1.5	50	276.6	145	17.8	6	15.8	134	3	26	7	470

Specification

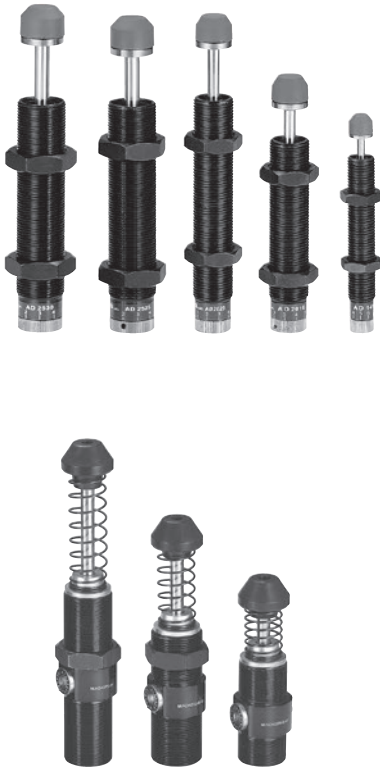

Model	Stroke (mm)	Max. Nm per cycle (Nm)	Max. Nm per hour (Nm)	Max. effective mass (kg)	Max. impact speed (m/s)	Without impact head	With impact head	Operating temp. (°C) (No freezing)	Stop collar (SC)	Flange (F)
MAD-1410	10	20	25000	80	3.0	○	○	-10~+80	SC-14	—
MAD-1415	15	24	26000	100	3.0	○	○	-10~+80	SC-14	—
MAD-1425	25	28	27500	140	3.0	○	○	-10~+80	SC-14	—
MAD-1612	12	22	27500	130	3.0	○	○	-10~+80	—	—
MAD-2016	16	28	27500	200	3.0	○	○	-10~+80	SC-20	—
MAD-2020	20	34	29000	298	3.5	○	○	-10~+80	SC-20	—
MAD-2025	25	39	30000	312	3.5	○	○	-10~+80	SC-20	—
MAD-2050	50	69	52000	420	3.5	○	○	-10~+80	SC-20	—
MAD-2525	25	85	54000	400	3.5	○	○	-10~+80	SC-25	—
MAD-2530	30	95	60000	480	3.5	○	○	-10~+80	SC-25	—
MAD-2540	40	100	80000	700	3.5	×	○	-10~+80	SC-25	—
MAD-2550	50	120	90000	720	4.0	○	○	-10~+80	SC-25	—
MAD-2580	80	150	120000	800	4.0	○	○	-10~+80	SC-25	—
MAD-2725	25	85	54000	400	3.5	○	○	-10~+80	SC-27	—
MAD-3625	25	150	81000	1400	3.0	×	○	-10~+80	SC-36	F36
MAD-3650	50	300	100000	2400	3.0	×	○	-10~+80	SC-36	F36
MAD-4225	25	260	125000	3000	3.5	×	○	-10~+80	—	F42
MAD-4250	50	500	150000	4000	4.5	×	○	-10~+80	—	F42
MAD-4275	75	750	180000	6000	4.5	×	○	-10~+80	—	F42
MAD-64050	50	1200	150500	12727	1.5	×	○	-10~+80	—	F64
MAD-64100	100	2400	200000	18181	1.5	×	○	-10~+80	—	F64
MAD-64150	150	3600	250000	23636	1.5	×	○	-10~+80	—	F64

Application example

Pick and place robot

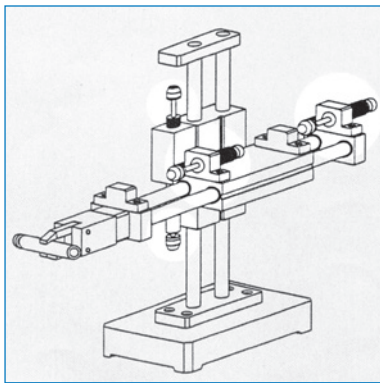

MAD series Adjustable

MAD series is of adjustable structure. When facing with different loads and different impact speeds, the adjustment knobs can be adjusted to appropriate scale to absorb perfectly the energy generated by the object. As compared to MAC series MAD series has higher energy absorption and wider applicable scope.

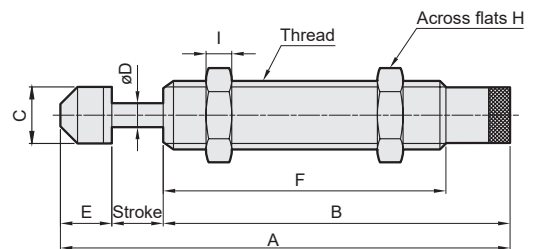

Press feed

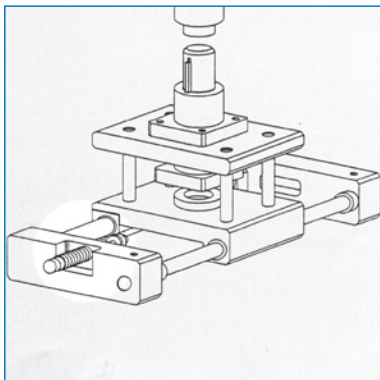

Dimensions

Model	Thread	Stroke (mm)	A	B	C	D	E	F	H	I	J	K	Weight (g)
MAD-1410	M14×1.0/1.5	10	109.7	88.5	12	4	11.2	72.5	19	5	—	—	90
MAD-1415	M14×1.0/1.5	15	128.2	102	12	4	11.2	86	19	5	—	—	120
MAD-1425	M14×1.0/1.5	25	153.2	117	12	4	11.2	101	19	5	—	—	194
MAD-1612	M16×1.0/1.5	12	99.7	76.5	14	4	11.2	54.9	19	6	—	—	200
MAD-2016	M20×1.5/2.0	16	148.3	117	17.8	6	15.3	101	26	7	—	—	230
MAD-2020	M20×1.5	20	152.3	117	17.8	6	15.3	101	26	7	—	—	235
MAD-2025	M20×1.5	25	157.3	117	17.8	6	15.3	101	26	7	—	—	240
MAD-2050	M20×1.5	50	239.3	174	17.8	6	15.3	158	26	7	—	—	330
MAD-2525	M25×1.5/2.0	25	162.5	118.5	22	8	19	101	32	9	—	—	350
MAD-2530	M25×1.5/2.0	30	167.5	118.5	22	8	19	101	32	9	—	—	365
MAD-2725	M27×1.5/3.0	25	162.5	118.5	22	8	19	101	32	9	—	—	403

MAD-2540

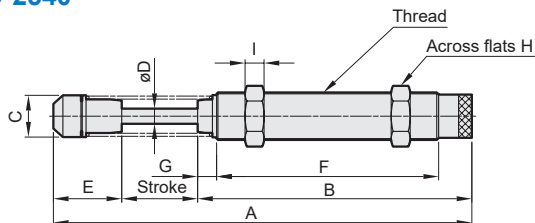

**MAD-3625
MAD-3650**

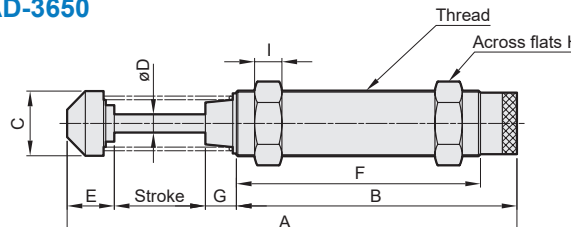

**MAD-2550
MAD-2580**

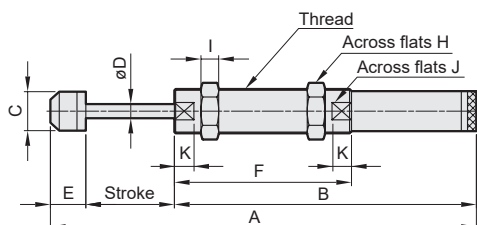

**MAD-4225
MAD-4250
MAD-4275**

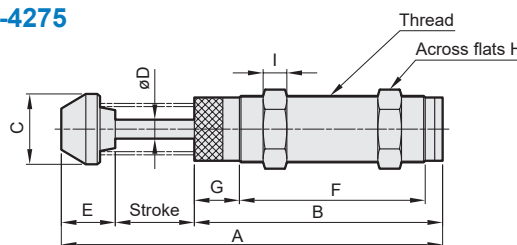

**MAD-64050
MAD-64100
MAD-64150**

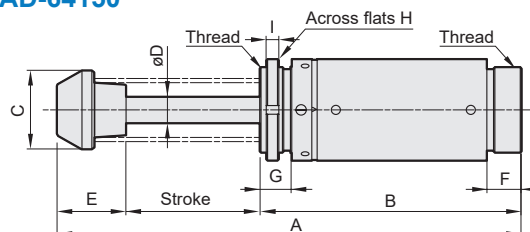

Dimensions

Model	Thread	Stroke (mm)	A	B	C	D	E	F	G	H	I	J	K	Weight (g)
MAD-2540	M25×1.5/2.0	40	221.5	144.5	22	8	37	117	10	32	9	—	—	455
MAD-2550	M25×1.5/2.0	50	247	178	22	8	19	100	—	32	9	22.8	11	455
MAD-2580	M25×1.5/2.0	80	343.5	244.5	22	8	19	100	—	32	9	22.8	11	585
MAD-3625	M36×1.5	25	184	133	35.5	10	26	103	10	46	15	—	—	955
MAD-3650	M36×1.5	50	247	171	35.5	10	26	134	17	46	15	—	—	1100
MAD-4225	M42×1.5	25	186.5	127.5	44.5	12	34	88	28.5	50	15	—	—	1280
MAD-4250	M42×1.5	50	241	157	44.5	12	34	117.5	28.5	50	15	—	—	1490
MAD-4275	M42×1.5	75	301.5	187.5	44.5	12	39	148	28.5	50	15	—	—	1710
MAD-64050	M64×2.0	50	247.8	146	59	20	51.8	26	24	76.2	9.4	—	—	4115
MAD-64100	M64×2.0	100	347.8	196	59	20	51.8	26	24	76.2	9.4	—	—	5280
MAD-64150	M64×2.0	150	467.8	256	59	20	61.8	26	24	76.2	9.4	—	—	6785



SC series – stop collars

Shock absorbers stop collars are available from M8×1.0 to M36×1.5 and suitable for shock absorbers with or Without impact head. They also can be used for adjusting and fixing position.

Optional accessories

Model	Dimensions	Applicable for shock absorber model
SC-08	M8×1.0 	MAC-0806
SC-10	M10×1.0 	MAC-1005 MAC-1007
SC-12	M12×1.0 	MAC-1210 MAD-1210
SC-14	M14×1.5 	MAC-1412 MAD-1410 MAC-1415 MAD-1415 MAC-1416 MAD-1425 MAC-1420 MAC-1425
SC-20	M20×1.5 	MAC-2015 MAD-2020 MAC-2020 MAD-2025 MAC-2025 MAD-2050 MAC-2030 MACD-2030 MAC-2050 MACD-2035 MAC-2065 MACD-2050
SC-25	M25×1.5 	MAC-2525 MAD-2525 MAC-2540 MAD-2530 MAC-2550 MAD-2540 MAD-2550 MAD-2580
SC-27	M27×1.5 	MAC-2725 MAD-2725
SC-36	M36×1.5 	MAC-3660 MAD-3625 MAD-3650

How to set stop collar

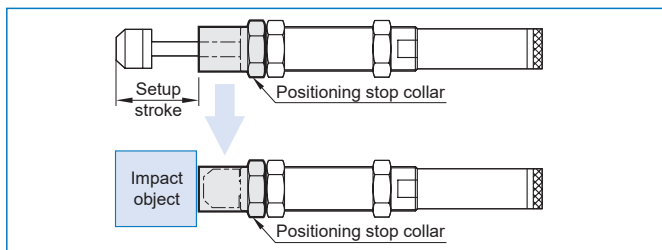

Flanges - F series

Model	Dimensions	Applicable for shock absorber model	Weight (g)
F36		MAC-3660 MAD-3625 MAD-3650	282
F42		MAD-4225 MAD-4250 MAD-4275	236
F64		MAD-64050 MAD-64100 MAD-64150	540