

2D/3D CAD download 【Procedure Demonstration】

Please log-in

 Anonymous login

! Caution







- Anonymous Login allows you to download 2D/3D files without an account.
- Please confirm the accurate product model number before generating the 3D model files.
- Also check the dimensions and tolerances from our newest catalog first since the profile of the 3D models are simplified for faster generating.
- If there is any specific dimension or tolerance not referred in our catalog, please contact our sales department.
- Simple Guide : Select the required product model number → Select "CAD download " at the left-bottom corner → Select the drawing format → Start download → Download
- Video Guide : 2D / 3D downloading procedure demonstration.
- PDF file : 2D / 3D downloading procedure demonstration.

1 Language



Available catalog languages:

 English  中文

2 Select the specification

MODEL Model	MVHT		
MF Model for F.R.L	300:for MA300 series		
TYPE Type	2H:2ways		
BN Bore no.	8A:Rc 1/4		
APPLY Apply to MVHT-400	Blank		
PT Port thread	Blank:Rc thread		

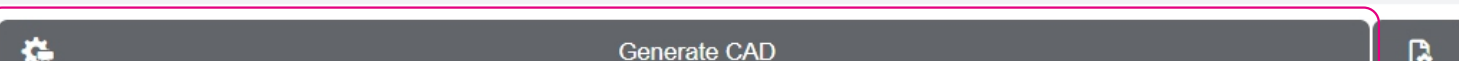

 Generate CAD 

 You have currently no CAD models available for download or mail delivery.

3 Generate CAD

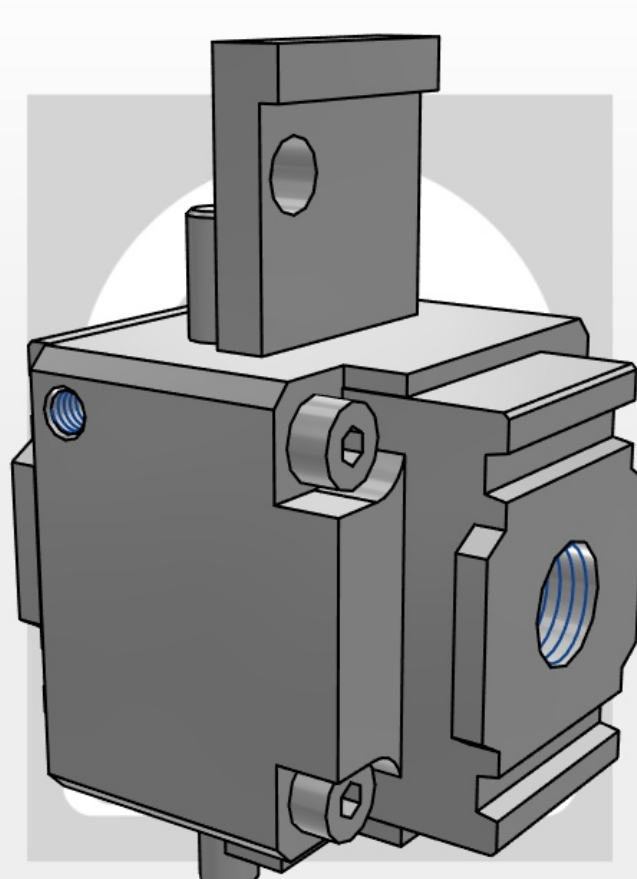

©2020 powered by CADENAS



Your selection Add formats Settings Layers & Views

 You have not selected any formats at the moment.

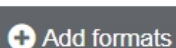

4 Add formats

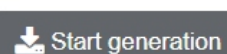







Your selection Add formats Settings Layers & Views

Q Search...

Select

Show 2D formats

Show 3D formats

5

Select the download format

 3D Studio MAX (3D)

 Allplan Macro (3D)

 ASCON C3D (3D)

 AutoCAD >=V14 (3D)

 Aveva PDMS / Marine (3D)

 BeckerCAD (3D)

 C3D KOMPAS (3D)

 Caddy++ SAT-V4.2 (3D)

 Catia (Macro)>=V5 (3D)

 Catia >=V5 (3D)

0 / 3 selected.

 MegaCAD SAT-V2.0 (3D)

 Metafile 3D (PS3) V2 (3D)

 Microstation (3D) (3D)

 NX 10 (3D)

 NX 11 (3D)

 NX 1847 (3D)

 NX 1872 (3D)

 NX 8 (3D)

 NX 8.5 (3D)

 NX 9 (3D)

Select the download format

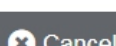





Your selection Add formats Settings Layers & Views

  DWG AUTOCAD VERSION 2010 - 2012 (2D) – Download

  Solid Edge ST9 (3D) – Download

  STEP AP214 (3D) – Download

 3/3 selected. Ordering several CAD formats will extend the generation / delivery time.











6 Start generation

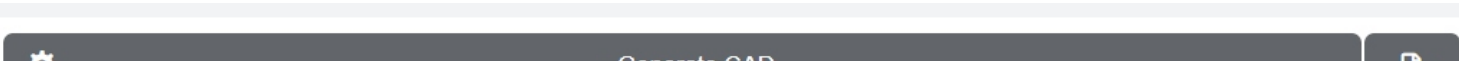



 Generate CAD 

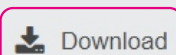

MVHT-302-3H-8A (CAD)



 Information  Delete

7 Download