

Reusable reel for Tubing comes in a box Tube Reel

● *Easy to Supply and Change Tube.*

● *4 Width Selections according to Tube Sizes.*

● *Reusable Reel.*

- The reel is reusable to reduce waste.
- Material of the reel is all plastic.

Model Designation (Example)

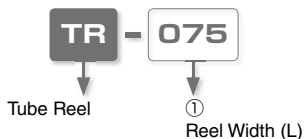

① Reel Width (L)

| Code | 075 | 100 | 160 | 200 |
|--------|-----|-----|-----|-----|
| L (mm) | 75 | 100 | 160 | 200 |

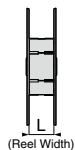

Specifications

| Model code | | TR-075 | TR-100 | TR-160 | TR-200 |
|-----------------------------|-----------|--------------------------|---------------|---------------|---------------|
| Applicable Tube dia. | mm size | ø4, ø6mm | ø8mm | ø10mm | ø12, 16mm |
| | inch size | ø1/8, ø5/32, ø3/16, ø1/4 | ø5/16 | ø3/8 | ø5/8, ø1/2 |
| Operating temperature range | | 14 ~ 122°F (-10 ~ 50°C) | | | |

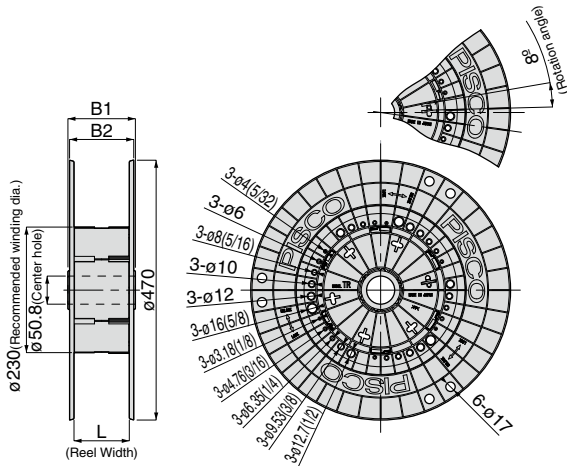

Unit : mm

| Model code | L | B1 | B2 | Weight (g) |
|------------|-----|-----|-----|------------|
| TR-075 | 75 | 97 | 91 | 1248 |
| TR-100 | 100 | 122 | 116 | 1270 |
| TR-160 | 160 | 182 | 176 | 1318 |
| TR-200 | 200 | 222 | 216 | 1357 |

※ : Tube shown in image is not included in the product.

⚠ Detailed Safety Instructions

Before using PISCO products, be sure to read "Safety Instructions" and "Safety Instruction Manual" and "Common Safety Instructions for Tubes".

Warning

1. Do not wind up a heavy load other than tubes on Tube Reel. There is a possibility of falling down of the heavy load by damaging the reel.

Caution

1. Avoid using Tube Reel out of the operating temperature range 14 ~ 122°F (-10~50°C). Otherwise, there is a possibility of deforming, dismantling and damaging it.
2. Since Tube Reel is made of resin, it should be handled with care.
3. Tube Reel is specially designed for PISCO Tubes.

Tube Reel Operation Manual

Please read this operation manual carefully so that the product can be used safely. Customers are requested to store this operation manual with great care.

⚠ Warning

- Don't load anything heavy other than tube on this product. Reel could be broken to allow the heavy object to drop.

⚠ Caution

- Don't use this product under any environment exceeding the range of operating temperature (-10 to 50°C). Product could be deformed, dismantled or broken.
- This product is made of resin, and should be handled with great care.
- Tube Reel is specially designed for PISCO Tubes.

Features

- It is very easy to reload/replace tubes.
- It contributes to environmental load reduction.
 - Reel can be used repeatedly, and the amount of waste material can be reduced.
- 4 types of reels are available in accordance with the tube diameter to be used. For the details, see the table below.

| Tube diameter (mm) | Model code | | | |
|-----------------------|------------|--------|--------|--------|
| | TR-075 | TR-100 | TR-160 | TR-200 |
| ø4(5/32) | ○ | | | |
| ø6 | ○ | | | |
| ø8(5/16) | | ○ | | |
| ø10 | | | ○ | |
| ø12 | | | | ○ |
| ø16(5/8) | | | | ○ |
| ø1/8 | ○ | | | |
| ø3/16 | ○ | | | |
| ø1/4 | ○ | | | |
| ø3/8 | | | ○ | |
| ø1/2 | | | | ○ |

Detail configuration of components (per set)

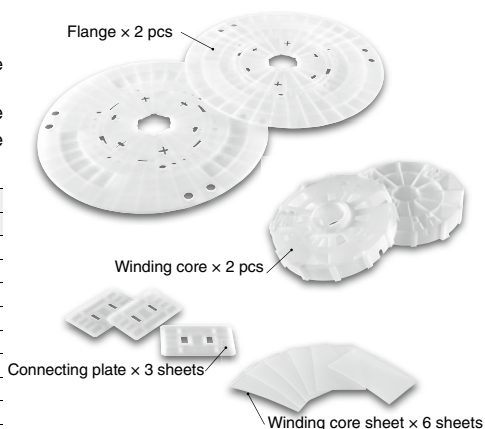

*1. Material: PP (polypropylene)

*2. The material might be changed due to our convenience.

How to assemble

- (1) Insert both ends of connecting plate into the grooves (at 3 places) on the winding cores.

Note) · Insert this firmly until it clicks. Clicking sound indicates that the unit is fixed.

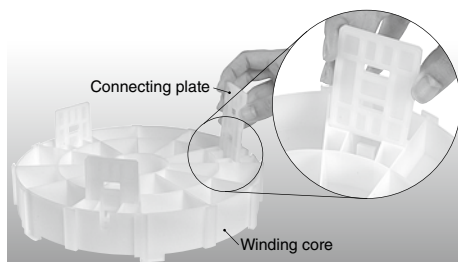

- (2) Similar to (1), insert the other winding core along the groove into the connecting plate which has been set.

Note) · Insert this firmly until it clicks. Clicking sound indicates that the unit is fixed.

- Be careful not to catch fingers between the parts.

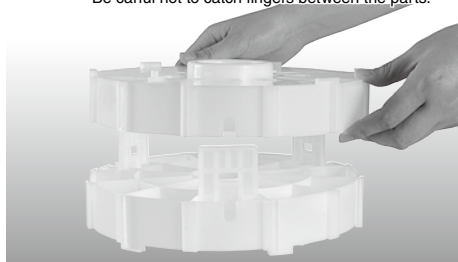

How to assemble

- (3) Loosen the winding core sheet, and fix it to the groove around the winding core (at 6 places).

Note) · Check if both ends of winding core are fixed firmly in the grooves of winding core.

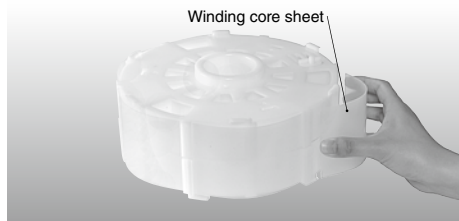

- (4) Fix the flange center hole into the convex part at center of winding core, and turn the flange counterclockwise.

Note) · Check if the logo PISCO is set on top.

- Check if the flange fixing claws (6 places) of winding core are fixed in the flange cutouts, and turn it in the counterclockwise.
- Turn until the flange clicks and is locked.

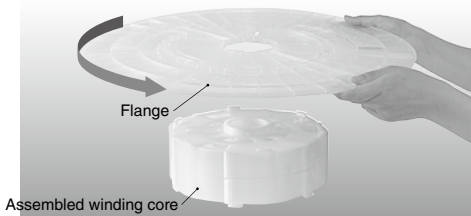

- (5) Load the tube, and make the inner tube terminal go through the insert hole of the flange to prevent the tube from idling.

Note) · Insert hole may indicate tube diameter. So insert the tube of corresponding tube diameter.
· Depending on tube binding shape, it might be necessary to load the tube by widening the inner binding diameter by hands.



- (6) Similar to the step (4), turn the flange counterclockwise after setting the flange. When assembly is completed, cut tube-binding tapes at 2 places, and make the tube outer terminal go through the tube insert hole to fix the tube.

Note) · Turn until the flange clicks and is locked.

- Be careful not to damage the tube when cutting tube-binding tapes.

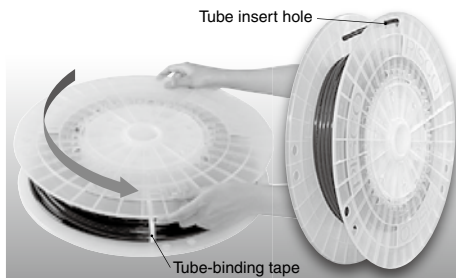

Reloading and replacing the tube

When reloading or replacing tubes, the flange can be unlocked by turning the flange in the clockwise while pressing the winding core button protruding from flange surface. Complete the reloading/replacement of tubes, thereafter, by the following procedures (5) to (6).

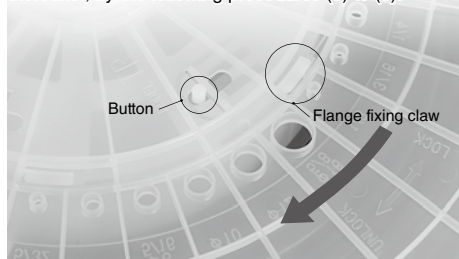



SAFETY Instructions

This safety instructions aim to prevent personal injury and damage to properties by requiring proper use of PISCO products.

Be certain to follow ISO 4414 and JIS B 8370

ISO 4414 : Pneumatic fluid power...Recommendations for the application of equipment to transmission and control systems.

JIS B 8370 : General rules and safety requirements for systems and their components.

This safety instructions is classified into "Danger", "Warning" and "Caution" depending on the degree of danger or damages caused by improper use of PISCO products.



Danger

Hazardous conditions. It can cause death or serious personal injury.



Warning

Hazardous conditions depending on usages. Improper use of PISCO products can cause death or serious personal injury.



Caution

Hazardous conditions depending on usages. Improper use of PISCO products can cause personal injury or damages to properties.



Warning

1. Selection of pneumatic products

- ① A user who is a pneumatic system designer or has sufficient experience and technical expertise should select PISCO products.
- ② Due to wide variety of operating conditions and applications for PISCO products, carry out the analysis and evaluation on PISCO products. The pneumatic system designer is solely responsible for assuring that the user's requirements are met and that the application presents no health or safety hazards. All designers are required to fully understand the specifications of PISCO products and constitute all systems based on the latest catalog or information, considering any malfunctions.

2. Handle the pneumatic equipment with enough knowledge and experience

- ① Improper use of compressed air is dangerous. Assembly, operation and maintenance of machines using pneumatic equipment should be conducted by a person with enough knowledge and experience.

3. Do not operate machine / equipment or remove pneumatic equipment until safety is confirmed.

- ① Make sure that preventive measures against falling work-pieces or sudden movements of machine are completed before inspection or maintenance of these machine.
- ② Make sure the above preventive measures are completed. A compressed air supply and the power supply to the machine must be off, and also the compressed air in the systems must be exhausted.
- ③ Restart the machines with care after ensuring to take all preventive measures against sudden movements.

Disclaimer

1. PISCO does not take any responsibility for any incidental or indirect loss, such as production line stop, interruption of business, loss of benefits, personal injury, etc., caused by any failure on use or application of PISCO products.
 2. PISCO does not take any responsibility for any loss caused by natural disasters, fires not related to PISCO products, acts by third parties, and intentional or accidental damages of PISCO products due to incorrect usage.
 3. PISCO does not take any responsibility for any loss caused by improper usage of PISCO products such as exceeding the specification limit or not following the usage the published instructions and catalog allow.
 4. PISCO does not take any responsibility for any loss caused by remodeling of PISCO products, or by combinational use with non-PISCO products and other software systems.
 5. The damages caused by the defect of Pisco products shall be covered but limited to the full amount of the PISCO products paid by the customer.
-



SAFETY INSTRUCTION MANUAL

PISCO products are designed and manufactured for use in general industrial machines. Be sure to read and follow the instructions below.

Danger

1. Do not use PISCO products for the following applications.
 - ① Equipment used for maintaining / handling human life and body.
 - ② Equipment used for moving / transporting human.
 - ③ Equipment specifically used for safety purposes.

Warning

1. Do not use PISCO products under the following conditions.
 - ① Beyond the specifications or conditions stated in the catalog, or the instructions.
 - ② Under the direct sunlight or outdoors.
 - ③ Excessive vibrations and impacts.
 - ④ Exposure / adhere to corrosive gas, inflammable gas, chemicals, seawater, water and vapor. *
* Some products can be used under the condition above(④), refer to the details of specification and condition of each product.
2. Do not disassemble or modify PISCO products, which affect the performance, function, and basic structure of the product.
3. Turn off the power supply, stop the air supply to PISCO products, and make sure there is no residual air pressure in the pipes before maintenance and inspection.
4. Do not touch the release-ring of push-in fitting when there is a working pressure. The lock may be released by the physical contact, and tube may fly out or slip out.
5. Frequent switchover of compressed air may generate heat, and there is a risk of causing burn injury.
6. Avoid any load on PISCO products, such as a tensile strength, twisting and bending. Otherwise, there is a risk of causing damage to the products.
7. As for applications where threads or tubes swing / rotate, use Rotary Joints, High Rotary Joints or Multi-Circuit Rotary Block only. The other PISCO products can be damaged in these applications.
8. Use only Die Temperature Control Fitting Series, Tube Fitting Stainless SUS316 Series, Tube Fitting Stainless SUS316 Compression Fitting Series or Tube Fitting Brass Series under the condition of over 60°C (140° F) water or thermal oil. Other PISCO products can be damaged by heat and hydrolysis under the condition above.
9. As for the condition required to dissipate static electricity or provide an antistatic performance, use EG series fitting and antistatic products only, and do not use other PISCO products. There is a risk that static electricity can cause system defects or failures.
10. Use only Fittings with a characteristic of spatter-proof such as Anti-spatter or Brass series in a place where flame and weld spatter is produced. There is a risk of causing fire by sparks.
11. Turn off the power supply to PISCO products, and make sure there is no residual air pressure in the pipes and equipment before maintenance. Follow the instructions below in order to ensure safety.
 - ① Make sure the safety of all systems related to PISCO products before maintenance.
 - ② Restart of operation after maintenance shall be proceeded with care after ensuring safety of the system by preventive measures against unexpected movements of machines and devices where pneumatic equipment is used.
 - ③ Keep enough space for maintenance when designing a circuit.
12. Take safety measures such as providing a protection cover if there is a risk of causing damages or fires on machine / facilities by a fluid leakage.

⚠ Caution

1. Remove dusts or drain before piping. They may get into the peripheral machine / facilities and cause malfunction.
2. When inserting an ultra-soft tube into push-in fitting, make sure to place an Insert Ring into the tube edge. There is a risk of causing the escape of tube and a fluid leakage without using an Insert Ring.
3. The product incorporating NBR as seal rubber material has a risk of malfunction caused by ozone crack. Ozone exists in high concentrations in static elimination air, clean-room, and near the high-voltage motors, etc. As a countermeasure, material change from NBR to HNBR or FKM is necessary. Consult with PISCO for more information.
4. Special option "Oil-free" products may cause a very small amount of a fluid leakage. When a fluid medium is liquid or the products are required to be used in harsh environments, contact us for further information.
5. In case of using non-PISCO brand tubes, make sure the tolerance of the outer tube diameter is within the limits of Table 1.

● Table 1. Tube O.D. Tolerance

| mm size | Nylon tube | Polyurethane tube | inch size | Nylon tube | Polyurethane tube |
|---------|------------|-------------------|-----------|------------|-------------------|
| ø1.8mm | — | ± 0.05mm | ø1/8 | ± 0.1mm | ± 0.15mm |
| ø3mm | — | ± 0.15mm | ø5/32 | ± 0.1mm | ± 0.15mm |
| ø4mm | ± 0.1mm | ± 0.15mm | ø3/16 | ± 0.1mm | ± 0.15mm |
| ø6mm | ± 0.1mm | ± 0.15mm | ø1/4 | ± 0.1mm | ± 0.15mm |
| ø8mm | ± 0.1mm | ± 0.15mm | ø5/16 | ± 0.1mm | ± 0.15mm |
| ø10mm | ± 0.1mm | ± 0.15mm | ø3/8 | ± 0.1mm | ± 0.15mm |
| ø12mm | ± 0.1mm | ± 0.15mm | ø1/2 | ± 0.1mm | ± 0.15mm |
| ø16mm | ± 0.1mm | ± 0.15mm | ø5/8 | ± 0.1mm | ± 0.15mm |

6. Instructions for Tube Insertion

- ① Make sure that the cut end surface of the tube is at right angle without a scratch on the surface and deformations.
- ② When inserting a tube, the tube needs to be inserted fully into the push-in fitting until the tubing edge touches the tube end of the fitting as shown in the figure below. Otherwise, there is a risk of leakage.

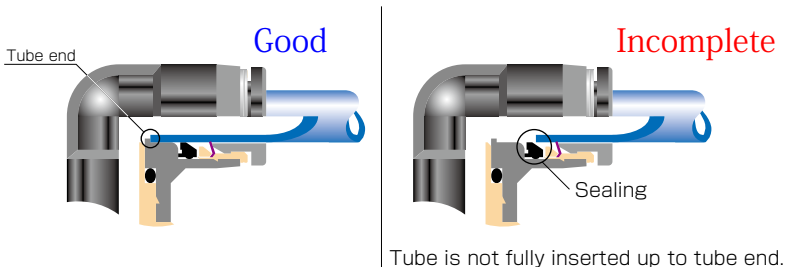

- ③ After inserting the tube, make sure it is inserted properly and not to be disconnected by pulling it moderately.
- ※ When inserting tubes, Lock-claws may be hardly visible in the hole, observed from the front face of the release-ring. But it does not mean the tube will surely escape. Major causes of the tube escape are the followings;
- ① Shear drop of the lock-claws edge
 - ② The problem of tube diameter (usually small)
- Therefore, follow the above instructions from ① to ③, even lock-claws is hardly visible.

7. Instructions for Tube Disconnection

- ① Make sure there is no air pressure inside of the tube, before disconnecting it.
- ② Push the release-ring of the push-in fitting evenly and deeply enough to pull out the tube toward oneself. By insufficient pushing of the release-ring, the tube may not be pulled out or damaged by scratch, and tube shavings may remain inside of the fitting, which may cause the leakage later.

8. Instructions for Installing a fitting

- ① When installing a fitting, use proper tools to tighten a hexagonal-column or an inner hexagonal socket. When inserting a hex key into the inner hexagonal socket of the fitting, be careful so that the tool does not touch lock-claws. The deformation of lock-claws may result in a poor performance of systems or an escape of the tube.
- ② Refer to Table 2 which shows the recommended tightening torque. Do not exceed these limits to tighten a thread. Excessive tightening may break the thread part or deform the gasket and cause a fluid leakage. Tightening thread with tightening torque lower than these limits may cause a loosened thread or a fluid leakage.
- ③ Adjust the tube direction while tightening thread within these limits, since some PISCO products are not rotatable after the installation.

● Table 2: Recommended tightening torque / Sealock color / Gasket materials

| Thread type | Thread size | Tightening torque | Sealock color | Gasket materials |
|----------------------------|-------------|-------------------|---------------|------------------|
| Metric thread | M3 × 0.5 | 0.7N·m | — | SUS304 NBR |
| | M5 × 0.8 | 1.0 ~ 1.5N·m | | |
| | M6 × 1 | 2 ~ 2.7N·m | | |
| | M3 × 0.5 | 0.7N·m | | POM |
| | M5 × 0.8 | 1 ~ 1.5N·m | | |
| | M6 × 0.75 | 0.8 ~ 1N·m | | |
| Taper pipe thread | M8 × 0.75 | 1 ~ 2N·m | White | — |
| | R1/8 | 4.5 ~ 6.5N·m | | |
| | R1/4 | 7 ~ 9N·m | | |
| | R3/8 | 12.5 ~ 14.5N·m | | |
| Unified thread | R1/2 | 20 ~ 22N·m | — | SUS304, NBR |
| | No.10-32UNF | 1.0 ~ 1.5N·m | | |
| National pipe thread taper | 1/16-27NPT | 4.5 ~ 6.5N·m | White | — |
| | 1/8-27NPT | 4.5 ~ 6.5N·m | | |
| | 1/4-18NPT | 7 ~ 9N·m | | |
| | 3/8-18NPT | 12.5 ~ 14.5N·m | | |
| | 1/2-14NPT | 20 ~ 22N·m | | |

※ These values may differ for some products. Refer to each specification as well.

9. Instructions for removing a fitting

- ① When removing a fitting, use proper tools to loosen a hexagonal-column or an inner hex bolt.
- ② Remove the sealant stuck on the mating equipment. The remained sealant may get into the peripheral equipment and cause malfunctions.

10. Arrange piping avoiding any load on fittings and tubes such as twist, tensile, moment load, shaking and physical impact. These may cause damages to fittings, tube deformations, bursting and the escape of tubes.



Common Safety Instructions for Tubes

Before selecting or using PISCO products, read the following instructions. Read the detailed instructions for individual series as well as the instructions below.

Warning

1. Avoid any load on Tubes such as tensile strength, twisting and bending. These may cause the crush, burst and escape of Tubes.
2. Protect Tubes from scratches caused by snagging or kinking. It may cause the burst of Tubes.
3. The burst pressure of Tubes drops as temperature rises. Read the operating pressure in the catalog well, and apply safety factor.
4. The minimum bending radius and the minimum installation radius are reference values at 20°C and 65% RH. They are not guaranteed values. Refer to the minimum bending radius when Tubes are wound around a mandrel (round bar). As for the other operating conditions, refer to the minimum installation radius. These values vary depending on operating environments or the tube length. In order to make sure the suitability of Tubes, carry out the operation test by the user's actual machine before using Tubes.
5. Place Insert Ring into the edge of soft tubes like UD Series or tubes inserted to Push-In Fittings with a water fluid. There is a possibility of escape of Tube without Insert Ring.
6. Only Anti-spatter Tube can be used under the flame and weld spatter condition. Otherwise, there is a possibility of danger to catch fire by sparks.
7. Only Soft Nylon Tube can be used for warm water or thermal oil. Otherwise, tubes may burst due to deterioration.
8. Only Anti-static Tube can be used under the condition required to dissipate static electricity or provide an anti-static performance. There is a possibility that static electricity can cause malfunction or other troubles with the system.
9. An abnormal rise in temperature due to adiabatic compression may cause damage to Tubes.
10. If Tubes are used with any fluid or under any condition / environment other than listed in the catalog, as well as used outdoors, the conformity evaluation with the actual machine and safety measures taken by the responsible person are highly recommended.

⚠ Caution

1. When bending tubes, observe the minimum bending radius and minimum installation radius.
2. When piping, provide sufficient lengths of tube, considering possible shrinkage.
3. When Tubes are inserted into Push-In Fitting, make sure that cut end surface of Tubes are right angle, without any scratches on the surface and deformations.
4. Note that the effective cross-section area varies by tube length. Refer to "Effective Area of Piping" in "Tube Performance" .

■ Minimum Bending Radius & Minimum Mounting Radius

1. Measurement method

● Minimum Bend Radius (JIS method)

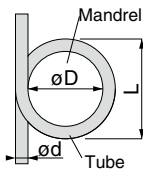

JIS method (based on JIS B8381)
Minimum Bending Radius is measured by winding a tube tightly around a mandrel.
Minimum Bending Radius is the value when the deformation ratio of the tube O.D. reaches 25%.
Measurement condition: 20℃
65%RH

$$n = \left(1 - \frac{L - D}{2d}\right) \times 100$$

n= Deformation ratio (%)

Standard: under 25%

d= Tube O.D.

L= Measured value (mm)

D= Mandrel diameter (mm)

● Minimum Installation Radius (Vice method)

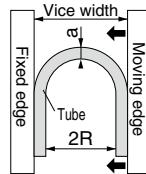

Fix the tube as the left figure shows. Slowly move the moving edge toward the fixed edge. When "a" deforms 25% from the initial value, the measured R is Minimum Installation Radius.
Measurement condition: 20℃
65%RH