

External Vacuum Controller with Blow-off Air and Relief Pressure Adjustment. External Vacuum Controller VJP Series

- *Pressure adjustment function and blow-off flow adjusting function, it enables to prevent works from being blown away.*
- *A relief mechanism built into the blow-off circuit which breaks the vacuum (extra pressure is relieved) realizes shorter blow-off time.*

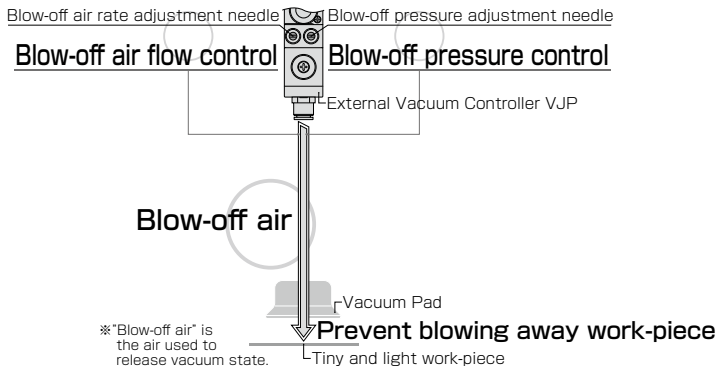

■ Characteristics

- *Wide variety of combinations enables to meet various applications. Complex vacuum generator VJ Series is also available (P.162)*
- *Manifold type is available. User-friendly wiring. 2 selections of pipe lead-out directions; Front lead-out type and rear lead-out type.*
- *3 Supply valve types*
 - *Double solenoid type (Vacuum retention type, selectable for saving energy)*
 - *Normally closed type*
 - *Normally open type*
- *Visibility improvement by adopting LED display for vacuum switch indication. There are 2 types of vacuum switch; 2 switch output and 1 switch output and analog output.*

Construction

Stand-alone type, Without vacuum switch

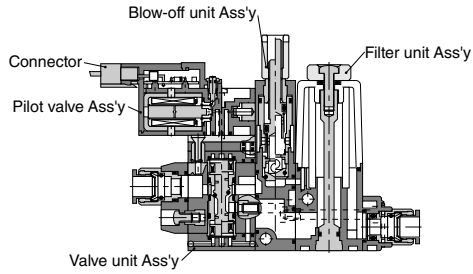

Stand-alone type, With vacuum switch

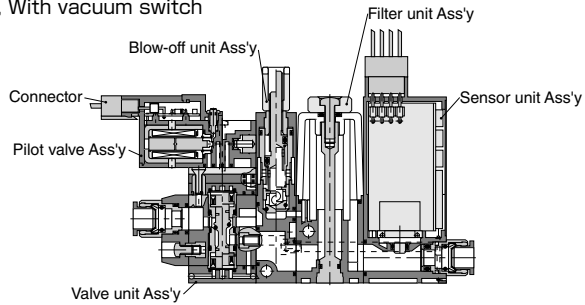

Manifold type, Without vacuum switch

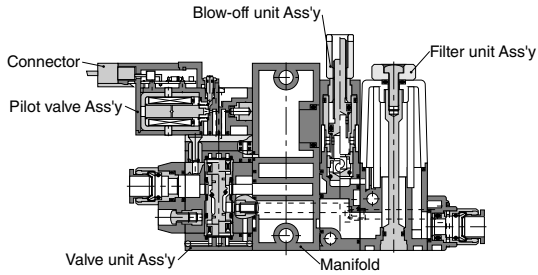

Manifold type, With vacuum switch

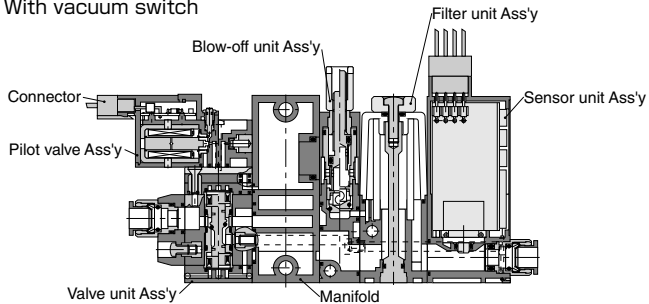

Model Designation (Example)

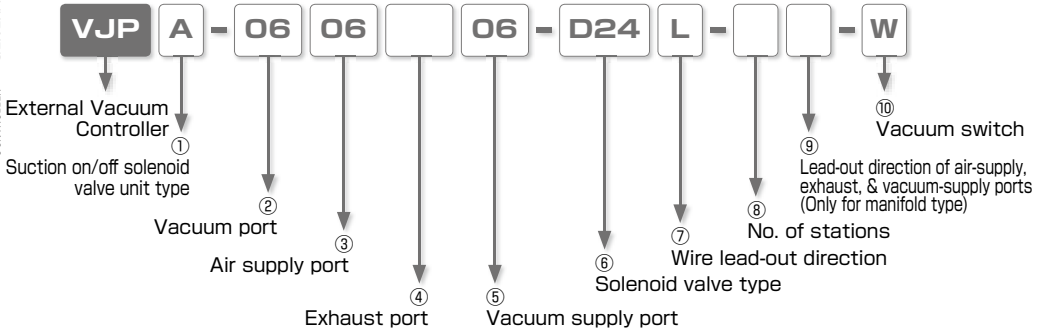

① Suction on/off solenoid valve unit type

Code	Valve unit	Code	Valve unit	Code	Valve unit
A	Double solenoid type (Vacuum retention type)	B	Normally closed type	C	Normally open type
K	Combination of different valve unit type on a manifold (Fill in the details on Specification Order Form)				

② Vacuum port (Applicable tube size)

Code	04	06	08
Tube dia.(mm)	ø4	ø6	ø8

00 : When different vacuum ports are mixed on a manifold (Fill in the details on Specification Order Form)

③ Air supply port (Applicable tube size)

Code	04	06	08	10
Tube dia.(mm)	ø4(※1)	ø6	ø8(※2)	ø10(※2)

※ 1. Stand-alone type only.

※ 2. Manifold type only.

④ Exhaust port (Applicable tube size)

Code	06	08	10
Tube dia.(mm)	ø6	ø8	ø10(※1)

⑤ Vacuum supply port (Applicable tube size)

Code	04	06	08	10
Tube dia.(mm)	ø4(※1)	ø6	ø8(※2)	ø10(※2)

※ 1. Stand-alone type only.

※ 2. Manifold type only.

⑥ Solenoid valve type

Code	D24	A100
Voltage	DC24V	AC100V

⑦ Wire lead-out direction

Code	L	S	K
lead-out direction	Top	Side	Different lead-out directions are mixed on a manifold (Fill in the details on Specification Order Form)

⑧ No. of stations (Only for manifold type)

Code	02	03	04	05	06	07	08	09	10
No. of stations	2	3	4	5	6	7	8	9	10

⑨ Lead-out direction of air-supply, exhaust, & vacuum-supply ports (Only for manifold type)

Code	A	B
Lead-out direction	Vacuum port side	Solenoid valve side

⑩ Vacuum switch

Code	W	A	K	No code
Switch	2 switch output	1 switch output and 1 analog output	When different vacuum switches are mixed on a manifold (Fill in the details on Specification Order Form)	Without vacuum switch

Order Example

1 External vacuum controller stand-alone type

VJP A - 04 04 06 - D24 L - W

① ② ③ ⑤ ⑥ ⑦ ⑩

- ① Suction on/off solenoid valve unit type :
A → Double solenoid type (Vacuum retention type)
- ② Vacuum port: **04** → ø4mm Push-In Fitting
- ③ Air supply port: **04** → ø4mm Push-In Fitting
- ⑤ Vacuum supply port: **06** → ø6mm Push-In Fitting
- ⑥ Solenoid valve type: **D24** → 24VDC
- ⑦ Wire lead-out direction: **L** → Top
- ⑩ Vacuum switch: **W** → 2 switch output

2 External vacuum controller manifold type

VJP A - 04 08 08 10 - D24 L - 04 A - W

① ② ③ ④ ⑤ ⑥ ⑦ ⑧ ⑨ ⑩

- ① Suction on/off solenoid valve unit type :
A → Double solenoid type (Vacuum retention type)
- ② Vacuum port: **04** → ø4mm Push-In Fitting
- ③ Air supply port: **08** → ø8mm Push-In Fitting
- ④ Exhaust port: **08** → ø8mm Push-In Fitting
- ⑤ Vacuum supply port: **10** → ø10mm Push-In Fitting
- ⑥ Solenoid valve type: **D24** → 24VDC
- ⑦ Wire lead-out direction: **L** → Top
- ⑧ No. of stations: **04** → 4 stations
- ⑨ Lead-out direction of air-supply, exhaust, & vacuum-supply ports: **A** → Vacuum port side
- ⑩ Vacuum switch: **W** → 2 switch output

3 External vacuum controller manifold type

(When any one of mounting units has a different specification on a manifold)

VJP K - 00 10 10 10 - D24 L - 05 A - K

① ② ③ ④ ⑤ ⑥ ⑦ ⑧ ⑨ ⑩

- ① Suction on/off solenoid valve unit type:
K → St.1, St.2 and St.3: Double solenoid type (Vacuum retention type)
 St.4, St.5: Normally closed type
- ② Vacuum port: **00** → St.1, St.2 and St.3: ø4mm Push-In Fitting
 St.4, St.5: ø8mm Push-In Fitting
- ③ Air supply port: **10** → ø10mm Push-In Fitting
- ④ Exhaust port: **10** → ø10mm Push-In Fitting
- ⑤ Vacuum supply port: **10** → ø10mm Push-In Fitting
- ⑥ Solenoid valve type: **D24** → 24VDC
- ⑦ Wire lead-out direction: **L** → Top
- ⑧ No. of stations: **05** → 5 stations
- ⑨ Lead-out direction of air-supply, exhaust, & vacuum-supply ports: **A** → Vacuum port side
- ⑩ Vacuum switch: **K** → St.1, St.2 and St.3: 2 switch output
 St.4: Without vacuum switch
 St.5: 1 switch output and analog output.

■ Specification Order Form(In case of order example of ③ in the left page)

Manifold type	Valve unit type ①	Vacuum port ②	Air supply port ③	Exhaust port ④	Vacuum supply port ⑤	Solenoid valve type ⑥	Wire lead-out direction ⑦	No. of stations ⑧	Lead-out direction of PS & EX ports ⑨	Vacuum switch ⑩	
											VJP
Mounting unit model code	L	St.1	A	06							W
	↑	St.2	St.1								
		St.3	St.1								
		St.4	B	08							
		St.5	B	08							A
		St.6									
		St.7									
		St.8									
		St.9									
	R	St.10									

※ When the top-mounting units for St. 1, St. 2 and St. 3 are of the same specifications as in the above example of specification order form, fill up the St. 1 space (uppermost) only, while entering "St. 1" in each of the St. 2 and St. 3 grids on the valve unit type column ①.

■ Manifold Type Example

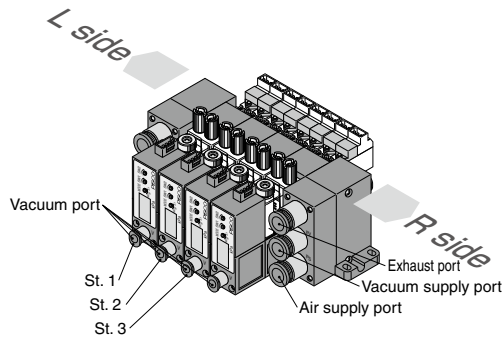

※ Station no. is arranged St.1, St.2 ... St.10 from L side.

External Vacuum Controller **VJP** Series Specification Order Form

To: NIHON PISCO CO., Ltd.

Name: _____

Order No.: _____

Date: _____

Request EX-W PISCO Date: _____ Quantity: _____

		Valve unit type ①	Vacuum port ②	Air supply port ③	Exhaust port ④	Vacuum supply port ⑤	Solenoid valve type ⑥	Wire lead-out direction ⑦	No. of stations ⑧	Lead-out direction of PS & EX ports ⑨	Vacuum switch ⑩
Manifold type	VJP	—					—		—		—
Mounting unit code	L ↑	St.1									
		St.2									
		St.3									
		St.4									
		St.5									
	R ↓	St.6									
		St.7									
		St.8									
		St.9									
		St.10									

※. Make a copy of this form and fill in it referring to the example in the previous page.

※. When the combination of mounting unit spec. is different, a separate Specification Order Form is required.

Mechanism of VJP

Example) VJPA-□□□-□□-□□-□ (Valve unit type: Double solenoid type (Vacuum retention type))

① At vacuum generation suspended

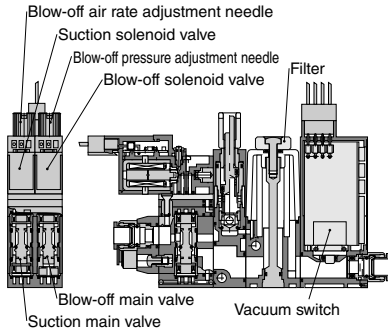

② At vacuum generating

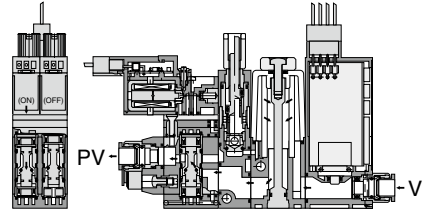

③ At vacuum retention

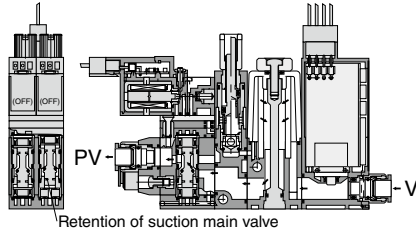

④ At blowing-off

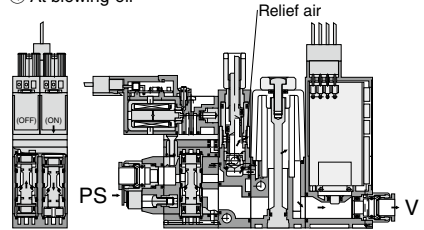

Example) VJPB-□□□-□□-□□-□ (Valve unit type: Normally closed)

① At vacuum generation suspended

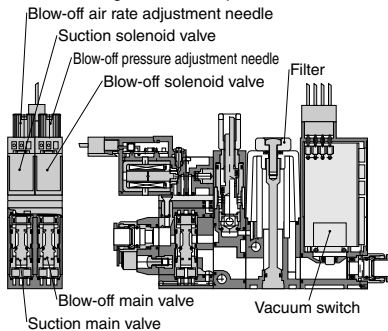

② At vacuum generating

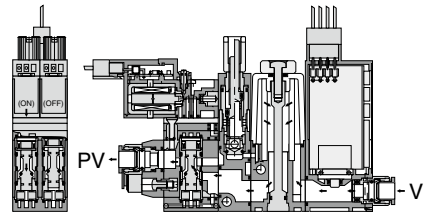

③ At vacuum retention

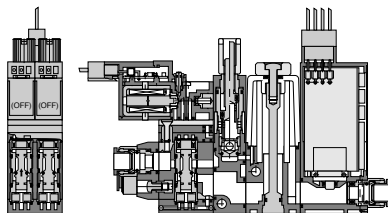

④ At blowing-off

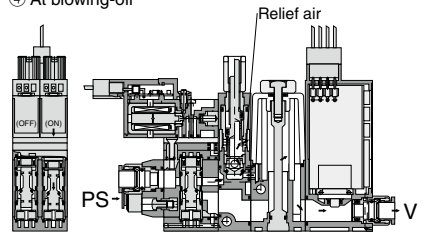

※ : V: Vacuum air / PS: Supply air / PV: Vacuum supply air

External Vacuum Controller Series

External Vacuum Controller VJP Series

Specification (Supply pressure)

Fluid medium	Air
Operating pressure range	0.3 ~ 0.7 MPa
Operating temp. range	5 ~ 50°C
Operating vacuum range	0 ~ -100kPa

Solenoid valve (Suction solenoid valve / Blow-off solenoid valve)

Pilot valves

Item	Suction solenoid valve		Blow-off solenoid valve	
Operating system	Direct operation			
Valve construction	Elastic seal, Poppet valve			
Rated voltage	DC24V	AC100V	DC24V	AC100V
Allowable voltage range	DC24V ±10%	AC100V ±10%	DC24V ±10%	AC100V ±10%
Surge protection circuit	Diode	Diode bridge	Diode	Diode bridge
Power consumption	1.2W (With LED)	1.5VA (With LED)	1.2W (With LED)	1.5VA (With LED)
Manual operation	Non-lock push-button type			
Operation indicator	Coil excitation: Red LED ON			
Wire connection method	Connector (Lead wire length: 500mm)			
	Red : DC24V Black : COM	Blue	Red : DC24V Black : COM	Blue

Switchover valve

Item	Suction main valve		Blow-off main valve
Operating system	Pneumatic operation by pilot valve		
Valve construction	Elastic seal, Poppet valve		
Proof pressure	1.05MPa		
Valve unit type	Double solenoid (retention)/ N.C. / N.O.		N.C.
Response time	50msec (Double solenoid type only)		—
Lubrication	Not required		
Effective sectional area	Air supply port (PV) size	ø4mm : 3.5mm ²	1mm ²
		ø6mm : 5mm ²	

Filter specification

Element material	PVF (Polyvinyl formal)	
Filtering capacity	10μm	
Filter area	1,130mm ²	
Replacement filter model code	Vacuum filter	VGFE 10
	Blow-off filter	VJFF

Blow-off function

Blow-off air rate	0 ~ 50l/min[ANR] (Rated supply pressure: 0.5Mpa)
Valve structure	Elastic seal, Poppet valve
Relief pressure setting range	0.005 ~ 0.05MPa

Vacuum switch with LED display

Output	2 switch output (-W)	1 switch output and 1 analog output (-A)
Current consumption	40mA max.	
Pressure detection	Diffused semiconduction pressure switch	
Operating pressure range	0 ~ -100kPa	
Pressure setting range	0 ~ -99kPa	
Proof pressure	0.2MPa	
Operating temp. range	0 ~ 50°C (No freezing)	
Operating humidity range	35 ~ 85%RH (No dew condensation)	
Rated voltage	DC12 ~ 24V ±10%, Ripple(P-P) 10% max.	
Protective structure	IEC standard IP40 equiv.	
No. of pressure setting	2	1
Operating accuracy	±3%F.S. max. (at Ta=25°C)	
Differential response	Fixed(2%F.S. max.)	Variable (about 0 ~ 15% of set value)
Switch output	NPN open collector output: 30V 80mA max. Residual voltage 0.8V max.	
Analog output	Output voltage	1 ~ 5V
	Zero-point voltage	1±0.1V
	Span voltage	4±0.1V
	Output current	1mA max. (load resistance 50kΩ max.)
	LIN/HYS	±0.5%F.S. max.
Response time	About 2m·sec. max	
Display	0 ~ -99kPa (2-digit red LED display)	
Display frequency	About 4 times / sec.	
Indication accuracy	±3%F.S. ±2 digit	
Sensor resolution	1 digit	
Operation indicator	SW1: Red LED turns ON, when pressure is above setting. SW2: Green LED turns ON, when pressure is above setting.	Red LED turns ON, when pressure is above setting.
Function	1. MODE switch (ME / S1 / S2)	1. MODE switch (ME / SW)
	2. S1 setting trimmer (2/3-rotation trimmer)	2. SW setting trimmer (2/3-rotation trimmer)
	3. S2 setting trimmer (2/3-rotation trimmer)	3. HYS setting trimmer (About 0-15% of setting value)

■ Circuit diagram (Solenoid valve)

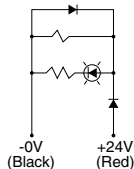

24VDC Supply/Blow-off solenoid valve

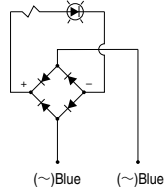

24VDC Supply/Blow-off solenoid valve

■ VJP Series Weight List

① Stand-alone type

Type	Model code	Weight(g)	Remarks
With vacuum switch	VJP□-□□□□-□□-□	152.0	Vacuum port : ø4, ø6
	VJP□-ø□□□-□□-□	158.5	Vacuum port : ø8
Without vacuum switch	VJP□-□□□□-□□	125.5	Vacuum port : ø4, ø6
	VJP□-ø□□□-□□	132.0	Vacuum port : ø8

② Manifold intermediate block

	Weight(g)	Remarks
Manifold intermediate block	18.5	Per station

③ Manifold Side block

	Weight(g)	Remarks
External Vacuum Controller	106.0	Cartridge qty: 6pcs

④ Cartridge (Supply and Exhaust ports)

Model code	Weight(g)	Remarks
CJC14-06	11.5	For ø6m
CJC14-08	10.0	For ø8m
CJC14-10	13.0	For ø10m

■ Calculate the total weight by the following calculation formula.

Total weight of manifold type = (① VJP Stand-alone unit + ② Manifold intermediate block) x station qty + ③ Manifold Side block + ④ Cartridge x qty

How to insert and disconnect

1. How to insert and disconnect tubes

① Tube insertion

Insert a tube into Push-In Fitting of the External Vacuum Controller VJP up to the tube end. Lock-claws bites the tube to fix it automatically and the elastic sleeve seals around the tube.

Refer to "2. Instructions for Tube Insertion" under "Common Safety Instructions for Fittings" .

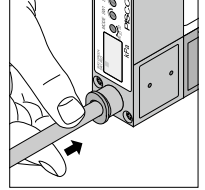

② Tube disconnection

The tube is disconnected by pushing release-ring to release Lock-claws.

Make sure to stop air supply before the tube disconnection.

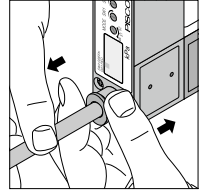

2. How to fix External Vacuum Controller VJP

In order to fix the vacuum controller, tighten M3 threads with tightening torque 0.3-0.35Nm through the fixing holes on the resin body. Refer to the outer dimensional drawings of the hole pitch.

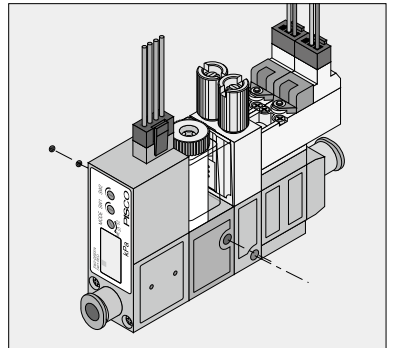

Applicable Tube and Related Products

Polyurethane Tube (1.Piping products catalog P.596)

■ Polyurethane Tube is for the general pneumatic piping and suitable for a compact piping.

Nylon Tube (1.Piping products catalog P.608)

■ Nylon Tube is for the general pneumatic piping and suitable for a high-pressure fluid up to 1.5MPa (NB tube: 1.0MPa).

Vacuum Tube (1.Piping products catalog P.612)

■ Vacuum Tube is a ultra-soft tube and suitable for piping of vacuum generators or actuators.

Vacuum Pads

- Vacuum Pad Standard Series · · · P.428
- Vacuum Pad Sponge Series · · · P.468
- Vacuum Pad Bellows Series · · · P.488
- Vacuum Pad Multi-Bellows Series P.508
- Vacuum Pad Oval Series · · · · P.526
- Vacuum Pad Soft Series · · · · P.550
- Vacuum Pad Soft Bellows Series P.578
- Vacuum Pad Skidproof Series · · P.604
- Vacuum Pad Ultrathin Series · · P.624
- Vacuum Pad Mark-free Series · · P.642
- Vacuum Pad Long Stroke Series · P.658

Standard Size List

Wire lead-out direction: top or side

Double solenoid type

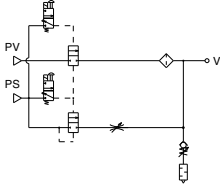

Normally closed type

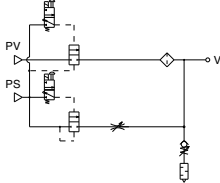

Normally open type

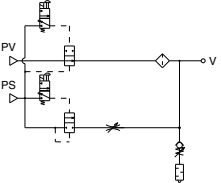

With vacuum switch, Wire lead-out direction: top or side

Double solenoid type

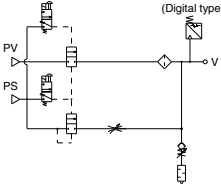

Normally closed type

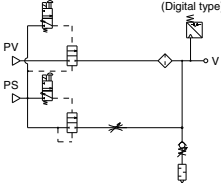

Normally open type

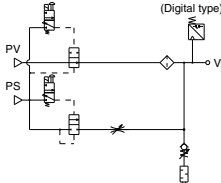

Type	Page to refer	Vacuum port	Air supply port		Vacuum supply port
			4mm	6mm	
VJP	332	4mm	●	●	8mm
			●	●	With Silencer
		6mm	●	●	8mm
			●	●	With Silencer
		8mm	●	●	8mm
			●	●	With Silencer

Type	Page to refer	Vacuum port	Air supply port		Vacuum supply port
			4mm	6mm	
VJP	333	4mm	●	●	8mm
			●	●	With Silencer
		6mm	●	●	8mm
			●	●	With Silencer
		8mm	●	●	8mm
			●	●	With Silencer

VJP Wire lead-out direction: Top



Model code

VJP□-□□□-□L

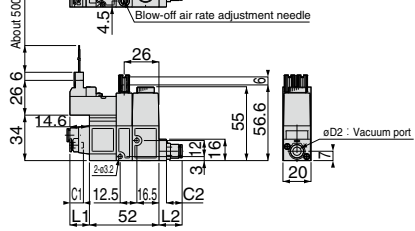
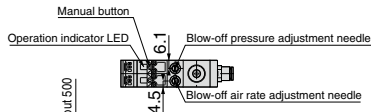
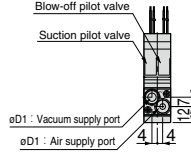

Unit: mm		
Air supply port Applicable tube size: øD1	C1	L1
4	11.2	14.6
6	11.7	17.1

Unit: mm		
Vacuum port Applicable tube size: øD2	C2	L2
4	10.9	14.3
6	11.7	17.2
8	21.7	25.8

Circuit diagram

VJPA... (Double solenoid stand-alone type)

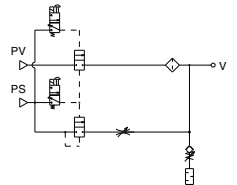

VJPB... (Normally closed stand-alone type)

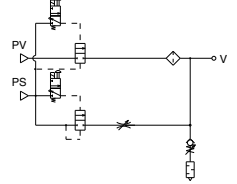

VJPC... (Normally open stand-alone type)

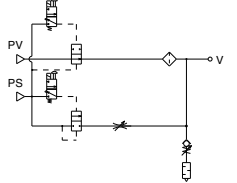

VJP Wire lead-out direction: Side



Model code

VJP□-□□□-□S

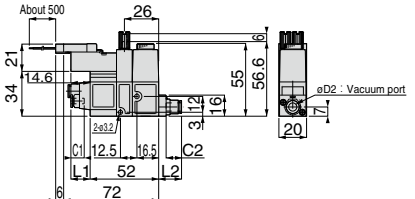
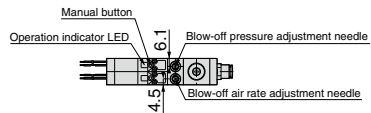
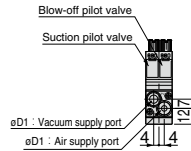

Unit: mm		
Air supply port Applicable tube size: øD1	C1	L1
4	11.2	14.6
6	11.7	17.1

Unit: mm		
Vacuum port Applicable tube size: øD2	C2	L2
4	10.9	14.3
6	11.7	17.2
8	21.7	25.8

Circuit diagram

See the above circuit diagram for the one for this type.

External Vacuum Controller Series

External Vacuum Controller VJP Series

VACUUM GENERATOR
EXTERNAL VACUUM CONTROLLER

VJP With vacuum switch, Wire lead-out direction: Top



Model code

VJP□-□□□-□L□

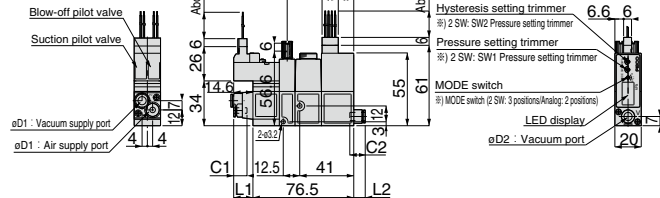

Unit: mm		
Air supply port Applicable tube size: øD1	C1	L1
4	11.2	14.6
6	11.7	17.1

Unit: mm		
Vacuum port Applicable tube size: øD2	C2	L2
4	10.9	5.8
6	11.7	8.7
8	18.2	17.3

Circuit diagram

VJPA...(Double solenoid stand-alone type)

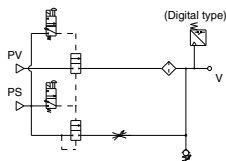

VJPB...(Normally closed stand-alone type)

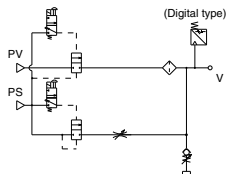

VJPC...(Normally open stand-alone type)

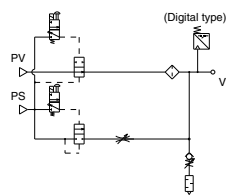

VJP With vacuum switch, Wire lead-out direction: Side



Model code

VJP□-□□□-□S□

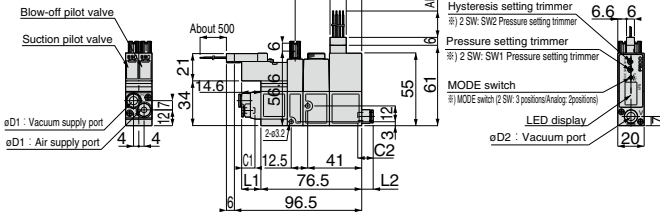

Unit: mm		
Air supply port Applicable tube size: øD1	C1	L1
4	11.2	14.6
6	11.7	17.1

Unit: mm		
Vacuum port Applicable tube size: øD2	C2	L2
4	10.9	5.8
6	11.7	8.7
8	18.2	17.3

Circuit diagram

See the above circuit diagram for the one for this type.



Manifold type,
Lead-out direction of PS & EX ports: Vacuum port side

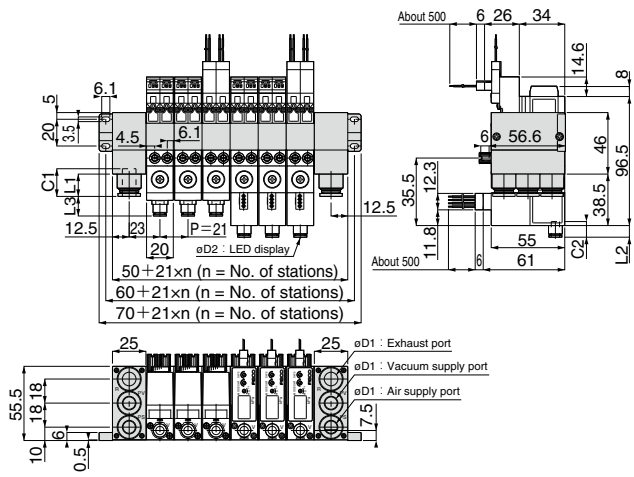

Model code
VJP□-□□□□-□□-□A-□

Unit: mm

Air supply and exhaust ports Applicable tube size: $\phi D1$	C1	L1
6	16.95	11.55
8	18.2	13.1
10	20.7	16.7

Unit: mm

Vacuum port Applicable tube size: $\phi D2$	C2	L2	L3
4	10.9	5.8	14.3
6	11.7	8.7	17.2
8	18.2	17.3	23.0

334



Manifold type,
Lead-out direction of PS & EX ports: Solenoid valve side

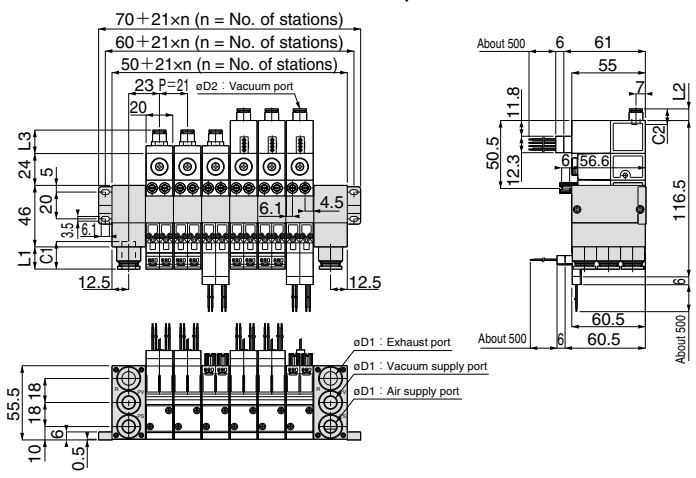

Model code
VJP□-□□□□-□□-□B-□

Unit: mm

Air supply and exhaust ports Applicable tube size: $\phi D1$	C1	L1
6	16.95	11.55
8	18.2	13.1
10	20.7	16.7

Unit: mm

Vacuum port Applicable tube size: $\phi D2$	C2	L2	L3
4	10.9	5.8	14.3
6	11.7	8.7	17.2
8	18.2	17.3	23.0

Before using PISCO products, be sure to read "Safety Instructions" and "Safety Instruction Manual" on page 35-39 and "Common Safety Instructions for Vacuum Series" on page 47-49.

Warning

1. Make sure that the leakage current is less than 1mA, when operating a valve unit. Leakage current larger than that may cause malfunction.
2. External vacuum controller with vacuum retention function permits some vacuum leakage. Provide an appropriate safety measure when vacuum retention for long period of time is required.
3. The coil in a pilot solenoid valve generates heat under the following ① to ③ conditions. The heat may cause dropping life cycle, malfunctions and burn or may affect negatively on peripheral machines. Contact us when the power is applied to the vacuum generator under the following conditions:
 - ① The power is continuously ON for over 2 hours.
 - ② High-cycle operation.
 - ③ Even when intermittent running of the generator is carried out,, the total operation time per day is longer than non-operation time.
4. When the electricity is applied to valves continuously for a long time, the coils generate heat. It may cause dropping life cycle, malfunctions, getting burnt or damaging peripheral machines due to the heat.
5. Regarding double-solenoid types (VJPA···), the switchover valve (main valve) is placed in neutral after the supply of pilot air has been suspended (the same is true when the valve is being operated for the first time after shipment). When resuming the supply of pilot air, be sure to send a signal to the pilot valve, or conduct switchover operations manually as required.

Caution

1. Do not give an excessive tensile strength and bending on a lead wire. Otherwise, breaking wire or damage on connector may be caused.
2. When manifold type is selected, dropping the performance or having an effect to other vacuum ports can be caused depending on number of stations or a combination of mounting units. Contact us for any unclear points.
3. Compressed air contains many kinds of drains such as water, oxidized oil, tar and other foreign substances. Dehumidify the compressed air by using an after-cooler or a dryer and improve the air condition, since those drains seriously impair the performance of the vacuum generator.
4. Do not use lubricators.
5. Since pipe rust cause malfunctions, a filter finer than 5 μ m should be placed right before the air supply port.
6. Do not use the vacuum generator under the condition of corrosive and / or inflammable gas. Also do not use these gasses as fluid medium.
7. Do not operate a blow-off valve during vacuum generating.
8. When replacing vacuum port cartridge, first remove any foreign matter clinging to them and the surrounding areas, then firmly insert pins into cartridges.
9. When replacing a supply port block, make sure not to lose the seal rubber and remove the foreign substances stuck around the block. Tighten the screw to fix the block with 0.27-0.3Nm of the tightening torque.

⚠ Safety Rules for Use

- 1. Safety Rules for Manifold Type → Refer to the precautions for Complex Vacuum Generator VJ on page 184.
 - 2. Vacuum Pressure Sensor (Vacuum switch) with LED display → Refer to the precautions for Complex Vacuum Generator VJ on page 184.
 - 3. How to adjust Relief Valve → Refer to the method for Complex Vacuum Generator VJ on page 185.
- ## ■ Replacement of Element

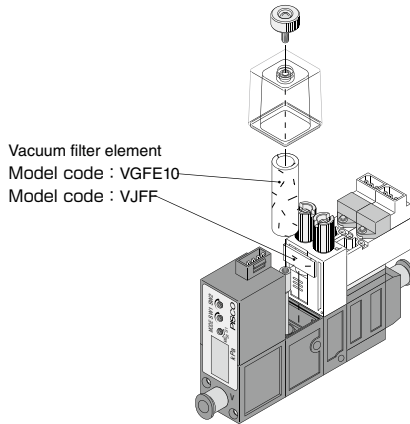

External Vacuum Controller Series

External Vacuum Controller VJP Series

VACUUM
GENERATOR

EXTERNAL VACUUM
CONTROLLER

337

VJP



SAFETY Instructions

This safety instructions aim to prevent personal injury and damage to properties by requiring proper use of PISCO products.

Be certain to follow ISO 4414 and JIS B 8370

ISO 4414 : Pneumatic fluid power...Recommendations for the application of equipment to transmission and control systems.

JIS B 8370 : General rules and safety requirements for systems and their components.

This safety instructions is classified into "Danger", "Warning" and "Caution" depending on the degree of danger or damages caused by improper use of PISCO products.



Danger

Hazardous conditions. It can cause death or serious personal injury.



Warning

Hazardous conditions depending on usages. Improper use of PISCO products can cause death or serious personal injury.



Caution

Hazardous conditions depending on usages. Improper use of PISCO products can cause personal injury or damages to properties.



Warning

1. Selection of pneumatic products

- ① A user who is a pneumatic system designer or has sufficient experience and technical expertise should select PISCO products.
- ② Due to wide variety of operating conditions and applications for PISCO products, carry out the analysis and evaluation on PISCO products. The pneumatic system designer is solely responsible for assuring that the user's requirements are met and that the application presents no health or safety hazards. All designers are required to fully understand the specifications of PISCO products and constitute all systems based on the latest catalog or information, considering any malfunctions.

2. Handle the pneumatic equipment with enough knowledge and experience

- ① Improper use of compressed air is dangerous. Assembly, operation and maintenance of machines using pneumatic equipment should be conducted by a person with enough knowledge and experience.

3. Do not operate machine / equipment or remove pneumatic equipment until safety is confirmed.

- ① Make sure that preventive measures against falling work-pieces or sudden movements of machine are completed before inspection or maintenance of these machine.
- ② Make sure the above preventive measures are completed. A compressed air supply and the power supply to the machine must be off, and also the compressed air in the systems must be exhausted.
- ③ Restart the machines with care after ensuring to take all preventive measures against sudden movements.

Disclaimer

1. PISCO does not take any responsibility for any incidental or indirect loss, such as production line stop, interruption of business, loss of benefits, personal injury, etc., caused by any failure on use or application of PISCO products.
2. PISCO does not take any responsibility for any loss caused by natural disasters, fires not related to PISCO products, acts by third parties, and intentional or accidental damages of PISCO products due to incorrect usage.
3. PISCO does not take any responsibility for any loss caused by improper usage of PISCO products such as exceeding the specification limit or not following the usage the published instructions and catalog allow.
4. PISCO does not take any responsibility for any loss caused by remodeling of PISCO products, or by combinational use with non-PISCO products and other software systems.
5. The damages caused by the defect of Pisco products shall be covered but limited to the full amount of the PISCO products paid by the customer.



SAFETY INSTRUCTION MANUAL

PISCO products are designed and manufactured for use in general industrial machines. Be sure to read and follow the instructions below.

Danger

1. Do not use PISCO products for the following applications.
 - ① Equipment used for maintaining / handling human life and body.
 - ② Equipment used for moving / transporting human.
 - ③ Equipment specifically used for safety purposes.

Warning

1. Do not use PISCO products under the following conditions.
 - ① Beyond the specifications or conditions stated in the catalog, or the instructions.
 - ② Under the direct sunlight or outdoors.
 - ③ Excessive vibrations and impacts.
 - ④ Exposure / adhere to corrosive gas, inflammable gas, chemicals, seawater, water and vapor. *
* Some products can be used under the condition above(④), refer to the details of specification and condition of each product.
2. Do not disassemble or modify PISCO products, which affect the performance, function, and basic structure of the product.
3. Turn off the power supply, stop the air supply to PISCO products, and make sure there is no residual air pressure in the pipes before maintenance and inspection.
4. Do not touch the release-ring of push-in fitting when there is a working pressure. The lock may be released by the physical contact, and tube may fly out or slip out.
5. Frequent switchover of compressed air may generate heat, and there is a risk of causing burn injury.
6. Avoid any load on PISCO products, such as a tensile strength, twisting and bending. Otherwise, there is a risk of causing damage to the products.
7. As for applications where threads or tubes swing / rotate, use Rotary Joints, High Rotary Joints or Multi-Circuit Rotary Block only. The other PISCO products can be damaged in these applications.
8. Use only Die Temperature Control Fitting Series, Tube Fitting Stainless SUS316 Series, Tube Fitting Stainless SUS316 Compression Fitting Series or Tube Fitting Brass Series under the condition of over 60°C (140° F) water or thermal oil. Other PISCO products can be damaged by heat and hydrolysis under the condition above.
9. As for the condition required to dissipate static electricity or provide an antistatic performance, use EG series fitting and antistatic products only, and do not use other PISCO products. There is a risk that static electricity can cause system defects or failures.
10. Use only Fittings with a characteristic of spatter-proof such as Anti-spatter or Brass series in a place where flame and weld spatter is produced. There is a risk of causing fire by sparks.
11. Turn off the power supply to PISCO products, and make sure there is no residual air pressure in the pipes and equipment before maintenance. Follow the instructions below in order to ensure safety.
 - ① Make sure the safety of all systems related to PISCO products before maintenance.
 - ② Restart of operation after maintenance shall be proceeded with care after ensuring safety of the system by preventive measures against unexpected movements of machines and devices where pneumatic equipment is used.
 - ③ Keep enough space for maintenance when designing a circuit.
12. Take safety measures such as providing a protection cover if there is a risk of causing damages or fires on machine / facilities by a fluid leakage.

⚠ Caution

1. Remove dusts or drain before piping. They may get into the peripheral machine / facilities and cause malfunction.
2. When inserting an ultra-soft tube into push-in fitting, make sure to place an Insert Ring into the tube edge. There is a risk of causing the escape of tube and a fluid leakage without using an Insert Ring.
3. The product incorporating NBR as seal rubber material has a risk of malfunction caused by ozone crack. Ozone exists in high concentrations in static elimination air, clean-room, and near the high-voltage motors, etc. As a countermeasure, material change from NBR to HNBR or FKM is necessary. Consult with PISCO for more information.
4. Special option "Oil-free" products may cause a very small amount of a fluid leakage. When a fluid medium is liquid or the products are required to be used in harsh environments, contact us for further information.
5. In case of using non-PISCO brand tubes, make sure the tolerance of the outer tube diameter is within the limits of Table 1.

● Table 1. Tube O.D. Tolerance

mm size	Nylon tube	Polyurethane tube	inch size	Nylon tube	Polyurethane tube
ø1.8mm	—	± 0.05mm	ø1/8	± 0.1mm	± 0.15mm
ø3mm	—	± 0.15mm	ø5/32	± 0.1mm	± 0.15mm
ø4mm	± 0.1mm	± 0.15mm	ø3/16	± 0.1mm	± 0.15mm
ø6mm	± 0.1mm	± 0.15mm	ø1/4	± 0.1mm	± 0.15mm
ø8mm	± 0.1mm	± 0.15mm	ø5/16	± 0.1mm	± 0.15mm
ø10mm	± 0.1mm	± 0.15mm	ø3/8	± 0.1mm	± 0.15mm
ø12mm	± 0.1mm	± 0.15mm	ø1/2	± 0.1mm	± 0.15mm
ø16mm	± 0.1mm	± 0.15mm	ø5/8	± 0.1mm	± 0.15mm

6. Instructions for Tube Insertion

- ① Make sure that the cut end surface of the tube is at right angle without a scratch on the surface and deformations.
- ② When inserting a tube, the tube needs to be inserted fully into the push-in fitting until the tubing edge touches the tube end of the fitting as shown in the figure below. Otherwise, there is a risk of leakage.

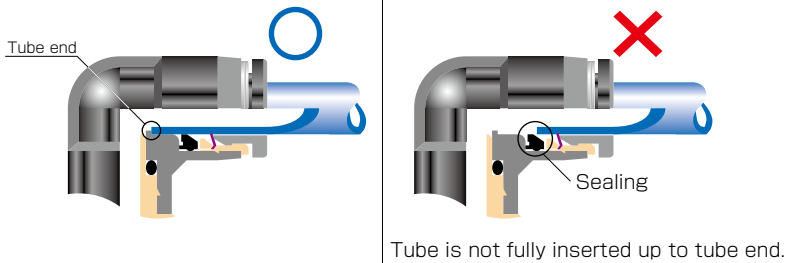

- ③ After inserting the tube, make sure it is inserted properly and not to be disconnected by pulling it moderately.
- ※ When inserting tubes, Lock-claws may be hardly visible in the hole, observed from the front face of the release-ring. But it does not mean the tube will surely escape. Major causes of the tube escape are the followings;
- ① Shear drop of the lock-claws edge
 - ② The problem of tube diameter (usually small)
- Therefore, follow the above instructions from ① to ③, even lock-claws is hardly visible.

7. Instructions for Tube Disconnection

- ① Make sure there is no air pressure inside of the tube, before disconnecting it.
- ② Push the release-ring of the push-in fitting evenly and deeply enough to pull out the tube toward oneself. By insufficient pushing of the release-ring, the tube may not be pulled out or damaged by scratch, and tube shavings may remain inside of the fitting, which may cause the leakage later.

8. Instructions for Installing a fitting

- ① When installing a fitting, use proper tools to tighten a hexagonal-column or an inner hexagonal socket. When inserting a hex key into the inner hexagonal socket of the fitting, be careful so that the tool does not touch lock-claws. The deformation of lock-claws may result in a poor performance of systems or an escape of the tube.
- ② Refer to Table 2 which shows the recommended tightening torque. Do not exceed these limits to tighten a thread. Excessive tightening may break the thread part or deform the gasket and cause a fluid leakage. Tightening thread with tightening torque lower than these limits may cause a loosened thread or a fluid leakage.
- ③ Adjust the tube direction while tightening thread within these limits, since some PISCO products are not rotatable after the installation.

● Table 2: Recommended tightening torque / Sealock color / Gasket materials

Thread type	Thread size	Tightening torque	Sealock color	Gasket materials
Metric thread	M3 × 0.5	0.7N·m	—	SUS304 NBR
	M5 × 0.8	1.0 ~ 1.5N·m		
	M6 × 1	2 ~ 2.7N·m		
	M3 × 0.5	0.7N·m		POM
	M5 × 0.8	1 ~ 1.5N·m		
	M6 × 0.75	0.8 ~ 1N·m		
Taper pipe thread	M8 × 0.75	1 ~ 2N·m	White	—
	R1/8	4.5 ~ 6.5N·m		
	R1/4	7 ~ 9N·m		
	R3/8	12.5 ~ 14.5N·m		
Unified thread	R1/2	20 ~ 22N·m	—	SUS304, NBR
	No.10-32UNF	1.0 ~ 1.5N·m		
National pipe thread taper	1/16-27NPT	4.5 ~ 6.5N·m	White	—
	1/8-27NPT	4.5 ~ 6.5N·m		
	1/4-18NPT	7 ~ 9N·m		
	3/8-18NPT	12.5 ~ 14.5N·m		
	1/2-14NPT	20 ~ 22N·m		

※ These values may differ for some products. Refer to each specification as well.

9. Instructions for removing a fitting

- ① When removing a fitting, use proper tools to loosen a hexagonal-column or an inner hex bolt.
- ② Remove the sealant stuck on the mating equipment. The remained sealant may get into the peripheral equipment and cause malfunctions.

10. Arrange piping avoiding any load on fittings and tubes such as twist, tensile, moment load, shaking and physical impact. These may cause damages to fittings, tube deformations, bursting and the escape of tubes.



Common Safety Instructions for Vacuum Series

Before selecting or using PISCO products, read the following instructions. Read the detailed instructions for individual series.

Warning

1. If there is a risk of dropping work-pieces during vacuum suction, take a safety measure against the falling of them.
2. Avoid supplying more than 0.1MPa pressure constantly in a vacuum circuit. Since vacuum generators are not explosive-proof, there is a risk of damaging the products.
3. Pay attention to drop of vacuum pressure caused by problems of the supplied air or the power supply. Decrease of suction force may lead to a danger of falling work-piece so that safety measure against the falling of them is necessary.
4. When more than 2 vacuum pads are plumbed on a single ejector and one of them has a suction problem such as vacuum leak, there is a risk of releasing work-pieces from the other pad due to the drop of the vacuum pressure.
5. Do not use in the way by which exhaust port is blocked or exhaust resistance is increased. Otherwise, there is a risk of no vacuum generation or a drop of the vacuum pressure.
6. Do not use the product in the circumstance of corrosive gas, inflammable gas, explosive gas, chemicals, seawater and vapor or do not expose the product to those. Never allow the product to suck those things.
7. Provide a protective cover on the products when it is exposed to sunlight.
8. Carry out clogging check for silencer element in an ejector and a vacuum filter periodically. Clogged element will be a cause to impair the performance or a cause of troubles.
9. Before replacing the element, thoroughly read and understand the method of filter replacement in the catalog.
10. Make sure the correct port of the vacuum generator by this catalog or marking on the products when plumbing. Wrong plumbing can be a risk to damage the product.
11. Supply clean air without sludge or dusts to an ejector. Do not lubricate by a lubricator. There is a risk of malfunction or performance impairing by impurities and oil contained in the compressed air.
12. Do not apply extreme tension, twist or bending forces on a lead wire. Otherwise, it may cause a wire breaking.
13. Locknut needs to be tightened firmly by hand. Do not use any tool to tighten. In case of using tools to tighten the locknut, it may damage the locknut or the product. Inadequate tightening may loosen the locknut and the initial setting can be changed.
14. Do not force the product to rotate or swing even its resin body is rotatable. It may cause damage to the product and a fluid leakage.
15. Do not supply an air pressure or a dry air to the products over the necessary amount. There is a risk of deteriorating rubber materials and malfunction due to oil.
16. Keep the product away from water, oil drops or dusts. These may cause malfunction. Take a proper measure to protect the product before the operation.

17. Do not use the product in the environment of inflammable or explosive gas / fluid. It can cause a fire or an explosion hazard.
18. Do not use the product in the circumstance of corrosive gas, inflammable gas, explosive gas, chemicals, seawater and vapor or do not expose the product to those. Otherwise, it may be a cause of malfunction.
19. Do not clean or paint the products by water or a solvent.

⚠ Caution

1. Operating pressure range in the catalog is the values during ejector operation. Secure the described value of the supplied air, taking a drop of the pressure into consideration. Insufficient pressure, which does not satisfy the spec, may cause abnormal noise, unstable performance and may negatively affect sensors, bringing troubles at last.
2. Effective cross-section area of the air supply side needs to be three times as large as effective cross-section area of the nozzle bore. When arranging piping or selecting PISCO products, secure required effective cross-section area. Insufficient supply pressure may be a cause to impair performance.
3. A Shorter distance of plumbing with a wider bore is preferable at vacuum system side. A long plumbing with a small bore may result in slow response time at the time of releasing work-piece as well as in failure to secure adequate suction flow rate.
4. Plumb a vacuum switch and an ejector with vacuum switch at the end of vacuum system as much as possible. A long distance between a vacuum switch and a vacuum system end may increase plumbing resistance which may lead to a high vacuum level at the sensor even when no suctioning and a malfunction of vacuum switch. Make sure to evaluate the products in an actual system.
5. Refer to "4. Instructions for Installing a fitting" and "5. Instructions for Removing a fitting" under "Common Safety Instructions for Fittings" , when installing or removing Fittings.
6. Refer to "Common Safety Instructions for Pressure Sensors" and "Detailed Safety Instructions" for the handling of digital vacuum switch sensor.
7. Refer to "Common Safety Instructions for Mechanical Vacuum Sensor" for the handling of mechanical vacuum switch.
8. The material of plastic filter cover for VG, VK, VJ, VZ and VX series is PCTG. Avoid the adherence of Chemicals below to the products, and do not use them under those chemical environments.

● Table Chemical Name

Chemical Name
Thinner
Carbon tetrachloride
Chloroform
Acetate
Aniline
Cyclohexane
Trichloroethylene
Sulfuric acid
Lactic acid
Water soluble cutting oil (alkaline)

* There are more chemicals which should be avoided. Contact us for the use under chemical circumstance.

VACUUM GENERATOR
EXTERNAL VACUUM CONTROLLER
VACUUM PAD
VACUUM ACCESSORIES
48
VH-VS
VU
VUM
VY
VB
VM-VC
VRL
VG
VK
VJ
VX
VQ
VZ
VN

9. The material of plastic filter cover for VQ and VFU series is PA. Avoid the adherence of chemicals below to the products, and do not use them under those chemical environments.

● Table Chemical Name

Chemical Name
Methanol
Ethanol
Nitric acid
Sulfuric acid
Hydrochloric acid
Lactic acid
Acetone
Chloroform
Aniline
Trichloroethylene
Hydrogen peroxide

* There are more chemicals which should be avoided. Contact us for the use under chemical circumstance.